

Securing What Matters

Product Directory 2021

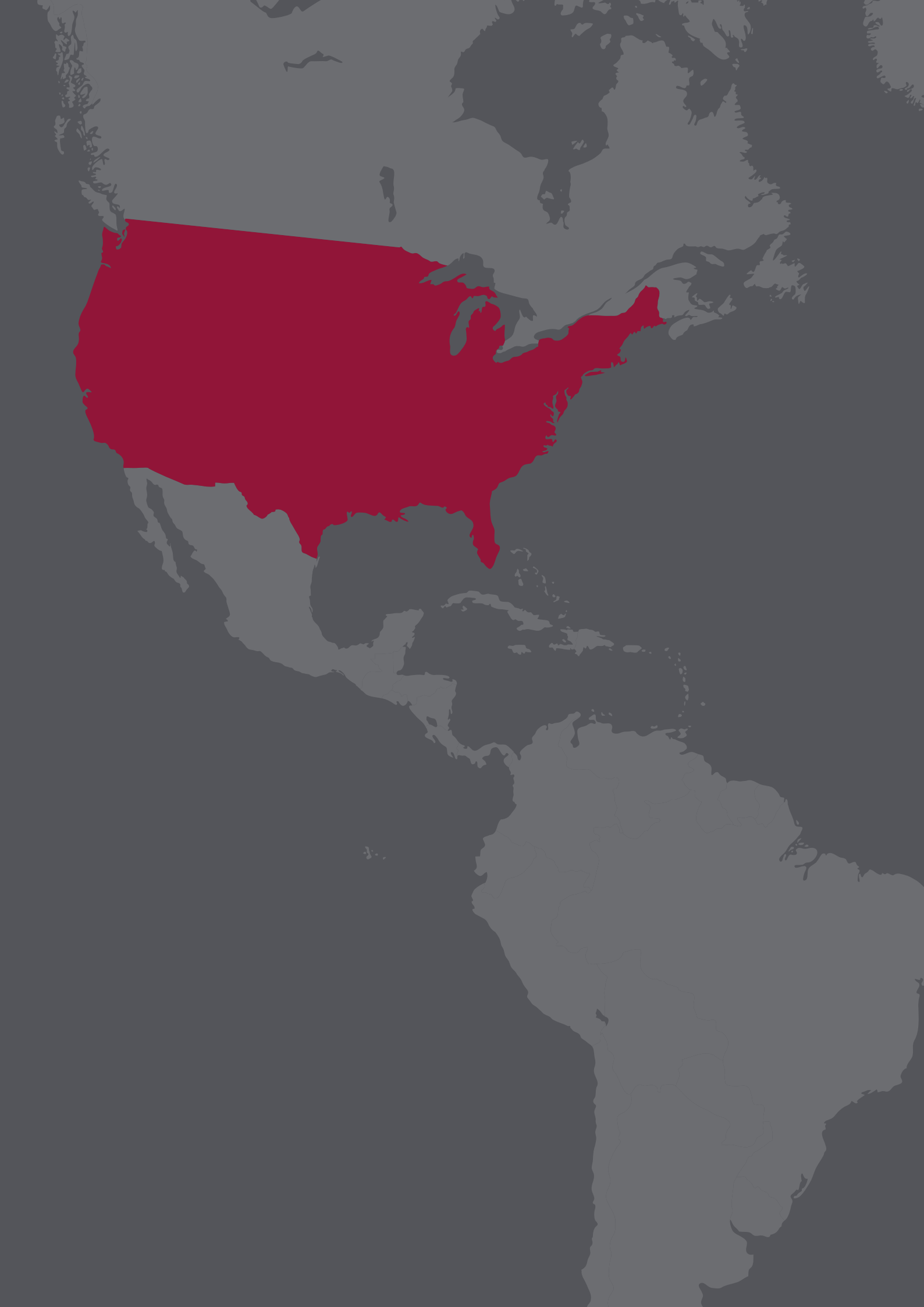



With 140 years of experience, Betafence is a global market leader in fencing solutions, access control, and detection. We manufacture perimeter protection systems of renowned quality to secure people, assets and businesses around the world.

Proud to be a PRÆSIDIAD brand, Betafence is part of a global network, working alongside Guardiar and Hesco as a leader in perimeter security systems and solutions.

Perimeter protection specialists Guardiar, provide security solutions for high security projects in oil & gas, data centers, energy & utilities and life safety solutions for schools, colleges and campuses.

Innovators and leading supplier of defensive barrier systems, Hesco manufacture protective structures, rapid deployment systems and flood protection products.



Our Products

We understand the need to feel safe and are committed to protecting everything people cherish and value.

PANEL SYSTEMS

Our flagship products are our Securifor® and Nylofor® range of welded mesh panels that deliver aesthetic protection across many levels of security requirements.

POSTS AND ACCESSORIES

Our posts and fixing options are specifically designed to fit, support, and enhance our fencing systems.

ROLL SYSTEMS

Ideal for long-distance perimeter demarcation and agricultural use, we offer a wide range to suit your needs.

GATES, BARRIERS AND TURNSTILES

Secure entry and exit points with our range of reliable products without compromising your level of protection.



Functionality

Our range of solutions will provide a complete perimeter security system.



DEMARICATION

An aesthetic fence or barrier to indicate a boundary and prevent accidental crossing.



ACCESS CONTROL

Various solutions to protect, control, and manage entry and exit to and from a site.



DISSUASION

An imposing barrier to deter breach attempts. It clearly indicates that entry is reserved for authorized persons only.

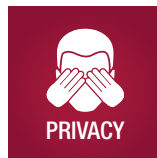

PRIVACY

Aesthetic and discreet solutions, compatible with our fencing systems, to create a safe and private environment.



DELAY

A high-security fence designed to delay perpetrators in order for security response teams to stop a breach attempt.



MOBILE SYSTEMS

Rapid deployment systems to quickly and easily create a temporary and movable boundary.

Our Coatings

The durability of PVC









Long lifetime

- Developed for extended durability in high corrosion environments (C4&5), increasing product lifespan.
- Ideal for marine and industrial environments.
- UV resistant PVC compound (passed 2500 hours QUV-B test).
- Coating durability proven by many years of application on welded/woven products on rolls and on welded panels.
- Thicker and more uniform coating layer.
- Thermoplastic PVC delivers flexibility and elasticity of the coating, resulting in excellent corrosion resistance, especially of flash weld points.

Environmental advantage

- Unique and environmentally friendly PVC composition:
 - No lead
 - No Cadmium
 - No CR6
 - No toxic plastic
- Coating process with low consumption of energy and minimal waste water.
- Long product lifetime results in lower global environmental impact.

Our colors

 Green RAL 6005 (panels)	 Black RAL 9005
 Green BF 6073 (rolls)	 Anthracite metallic BF 7016 M
 White RAL 9010	 Anthracite RAL 7016

Check the product pages for detailed information

The color of Polyester











Customer tailored solutions

- Attractive decorative coatings, available in a range of finishes: very smooth, metallic look or textured appearance.
- Wide product range and great flexibility: almost any panels, posts and gates can be produced using these decorative coatings.

Consistent high-quality coating

- Stringent process control assures consistent quality.
- UV resistant Polyester compound (passed 2500 hours in QUV-A test).
- State of the art technology guarantees the highest quality.
- Thermoset Polyester delivers a solid coating layer.

Our colors

 Green RAL 6005	 Black RAL 9005
 White RAL 9010	 Anthracite RAL 7016
 Green RAL 6009	 Blue RAL 5010
 Grey RAL 7030	 Grey RAL 9006
 Anthracite metallic BF 7016 M	

*Available colors depending on the product lines
This is an overview of all current colors.
Other colors are available on request.*

Our Coating Guarantee

Quality: a way of working

Betafence continuously invests in quality during all stages of our production processes.

We have three main quality objectives:

- To realize true satisfaction of our customers
- To efficiently manage our key processes
- To continuously improve

Our ISO-9001:2015 quality certification guarantees that our customers are always assured of receiving the best quality products.

We guarantee quality

For PVC and PES coated products, Betafence offers 10 years guarantee in non-aggressive environments and in high-corrosive environments when our specifically developed coatings are used. Detailed terms and conditions on our complete guarantee policy, for both residential and professional sectors, is available on our website or contact your local sales office for more information.

Quality controlled

The product quality is constantly tested and evaluated. Stringent quality requirements on our coatings assure a very long product lifetime, even in aggressive environments.

Our quality zinc and plastic, and superior ZincaLu® coatings meet the highest standards in the market.

- Salt spray test for polyester coatings: max. 10 mm loss of adhesion after 1000 hours salt spray, tested according to the standard ISO 9227.
- Kesternich test (SO2 test) for polyester coatings: max. 10 mm loss of adhesion after 25 cycles, tested according to standard ISO 3231.
- UV-tests for PVC and polyester coatings simulate the resistance to deterioration due to sunlight, humidity and temperature, tested according to standard ISO 11507.



Environmental Responsibility

Our corporate responsibility towards our people and the environment is central to our daily lives at Betafence. We monitor our Health & Safety and Environmental practices with care, transparency and reliability.

Reduce, reuse and recycle

We continuously assess and improve our processes to meet objectives set out in the following categories:

- Adherence to applicable laws and regulations
- Reduction of energy consumption and heat recuperation
- Reduction of CO² emissions
- Efficient use of raw materials and water
- Investing in alternative energy sources
- Responsible recycling of materials

Our products

- The long lifetime of our coated products is the most important contributor to Betafence's reduced long term impact on the environment and natural resources.
- Installing a Betafence fencing system is a life time investment, however, should the need arise, our products can be recycled through steel recycling processes.
- We ensure our raw materials are free of harmful or toxic compounds.

Our people

In today's world, we recognize that the health and safety of our people is central to our success. We depend on the well-being and talents of our people and commit to creating a healthy, safe and accident-free working environment. Supporting the rights of all, we have a respectful workplace culture that is free of harassment, intimidation, bias and unlawful discrimination and labor practices of any kind.

Visualize your project with our free fence simulator tool

- Configure your fence or gate in 5 steps.
- See the result using your own photo and measurements.
- Test different fence colors and systems including our Bekafor, CreaZen, and Zenturo fencing ranges.
- Share your project with friends, installers, and wholesalers.

Find our simulator tool at betafence.com

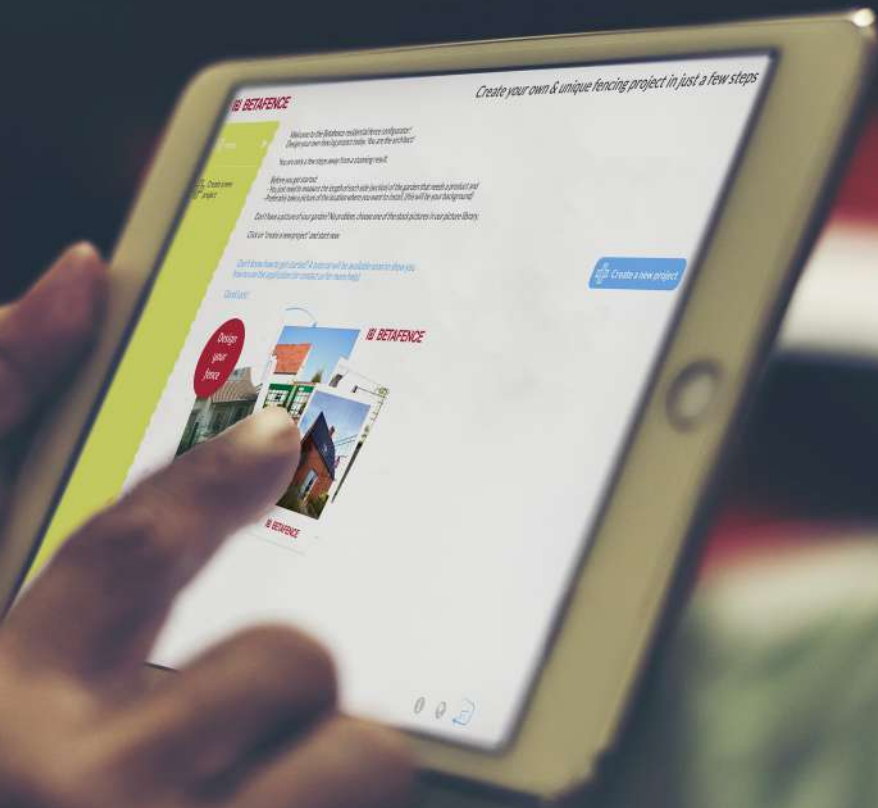

Become a Betafence Expert with Betafence Academy

We are proud to offer advanced fencing systems for nearly any requirement, and we want to assist our partners to make the best possible use of our products key selling points.

This is why we created Betafence Academy.

Betafence Academy is a comprehensive training and certification program specifically developed to give you the tools you need to successfully grow your sales. Covering a wide range of Betafence's fencing systems and applications, the modules will give you the product knowledge and insight to confidently help your customers pick the right fence for their needs.

Start your journey to become a Betafence expert today!

Learn more about Betafence Academy at betafence.com





Supporting Specification

Access to the right information is crucial. Betafence developed a range of resources to ensure you are supported at every specification and visualization stage of your project.

BIM Objects

- Popular Betafence panel, post and gate models available
- Revit and IFC format
- Accurate geometric data and product information
- Easier, more accurate specification and fence design
- Quality assurance – Uniclass 2015 classification

NBS National BIM Library | BIM Object



3D Product View

- Rotate Betafence panels, posts and gates 360° and view them from any angle
- Manipulate images for a detailed understanding of components and profiles
- Visualize how our systems will complement your project
- Download 3D image views from any angle

Tender Tool

- Automatically generate detailed specification documents directly from betafence.com at the click of a button
- Simply select the required Betafence panel, post and gate for your project
- Receive a detailed specification document including descriptions, diagrams, Standards, range dimensions and finishing options
- Q40 documents are also available for UK customers

Approved Training Courses

- Free approved CPD seminars
- Available on-line or in person at a time that suits you
- Topics range from the fundamentals of fencing to securing infrastructure
- Training courses can be used to support annual training programs or as a stand-alone course



SOUTH AFRICAN
INSTITUTE OF
ARCHITECTS
SAIA
saarchitecture.co.za

AIA
Continuing
Education
Provider





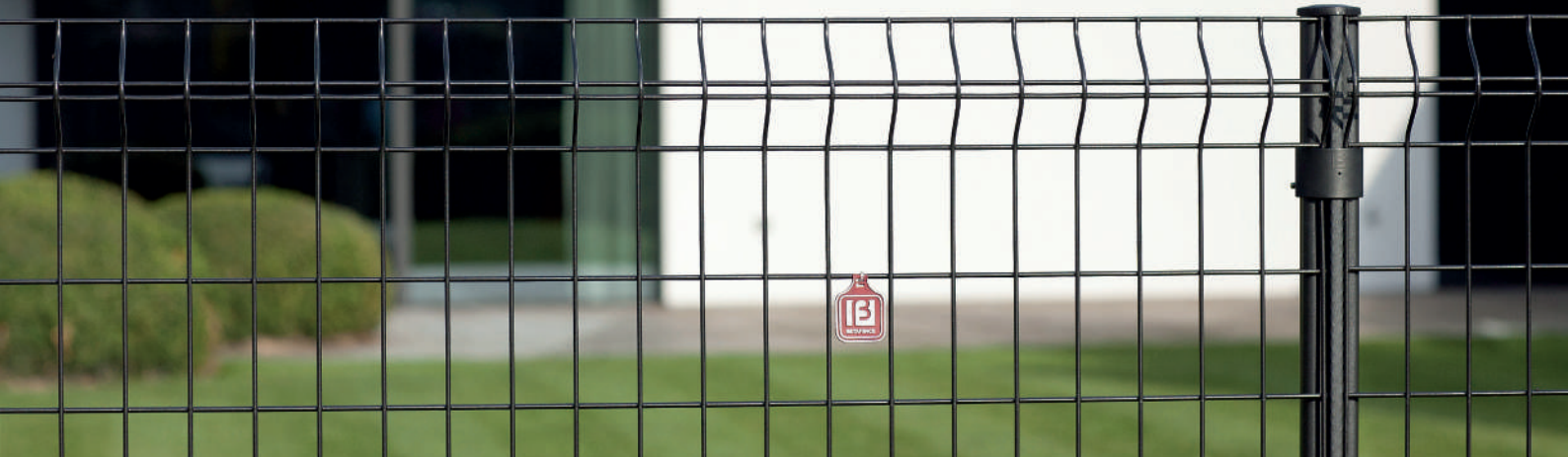

Bekafor® Classic

Panels

Bekafor Classic is a rigid panel fence system that protects house and garden in a classic way

Product detail

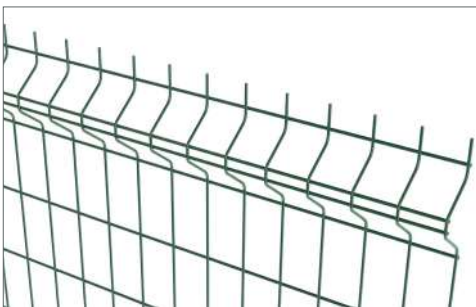

BENEFITS

High longevity

This system offers certified quality and lifetime, as the panels are made of galvanised steel wire, plastic coated afterwards with high adhesion.

Easy installation

The complete system of several panel heights and convenient posts, collars, accessories (floor plates, corner clips and wall fixators) and gates offer a solution for all situations. This system can even be installed on a wall or concrete floor.

Classic design

Blending into the garden, Bekafor Classic provides peace of mind combined with classic design. The high rigidity of this residential fence helps you to border your garden in a durable way and its design makes it very discreet. The panels have vertical barbs at one side that can be placed at the top for a more protective fence. The panels can be completed with an infill to enhance privacy (Bekafor Collfort & Bekafor Screeno Line).

Security level



Applications



RESIDENTIAL

Functionalities



DEMARICATION

PRIVACY AVAILABLE

Panels

The panels have a width of 2000 mm and are available in a range of heights from 630 till 2030 mm. The panels have vertical barbs of 30 mm that can be placed at the top or at the bottom (place the barbs at the top for panel heights \geq 1530 mm)

The horizontal curves give the panels extra rigidity.

Mesh sizes are 100 x 50 mm

Wire diameter horizontal wires: 4,5 mm

Wire diameter vertical wires: 4 mm

Posts and fixation



Bekaclip posts

Bekafor Classic panels can be installed with metal Bekaclip posts, (diam. 48 mm). The panels can be easily fixed to the posts by making use of the special Bekafor collets.

In combination with Collfort slats, the posts have a diameter of 60 mm.



Izifix post system

Lateral fixing of the Bekafor Classic panels in the Izifix post, without accessories. Perfect fixing of the curves of the panel in the post profile. The Izifix posts (75 x 50 mm + slots every 100 mm) are covered with a plastic cap.

Not recommended in combination with Collfort or Screeno line infill.

Gates

Bekafor Classic fences can easily be combined with single and double Bekafor Classic gates & single Bekafor Essential gates.



Coating technique

Panels are made out of galvanized wires. A pre-treatment process guarantees a perfect PVC-coating adhesion to the product surface.

The posts are galvanized inside & out (min. coating 275g/m², both sides together), in accordance with Euro standard EN 10346. Afterwards an adhesion coating is applied and finally the posts are PES coated (min. 60 micron).

Options

Several accessories are available for:

- fixing a panel directly to a wall (wall fixators)
- installing posts on a concrete floor or wall (base plates)
- installing panels in an angle (corner clips)

Infills

Infills available to create privacy

- Collfort (wooden slats)
- Screeno Line (PVC slats)

Colors

Green RAL 6005 - Anthracite BF7016M

ASSORTMENT BEKAFOR CLASSIC

Fence height mm	Dimensions panels width x height mm	Height post to be put in concrete mm	Height post to be put in base plate mm	Bekaclip Posts Number of collets per post
630	2000 x 630	1100	700	2
1030	2000 x 1030	1500	1100	2
1230	2000 x 1230	1700	1300	3
1530	2000 x 1530	2000	-	3
1730	2000 x 1730	2300	-	4
2030*	2000 x 2030	2500	-	4





Zenturo® Classic

Panels

Zenturo Classic is a universal “all-in-one” solution for limitless contemporary fencing and garden decoration concepts. Design your own fence!

Product detail



BENEFITS

Versatility

The Zenturo Classic panel can be used as a fencing panel, for the creation of privacy or as a climbing plant support. More over, unique compatible Zenturo Classic infills are available to give a creative, personal touch to the fence.

Innovative design

The flat garden panel is very attractive, thanks to its combination of different mesh sizes and double, alternating horizontal wires. The panel is available in fashionable metallic anthracite color. Other colors are available on demand. The different Zenturo Classic panel infills offer a multitude of attractive configurations!

Easy installation

The Zenturo Classic panels can be installed with the Bekaclip post systems for (with Bekafor accessories). Specific tools or experience in installation are not required!

Security level



Applications



Functionalities



Panels

The Zenturo Classic panel is a flat panel, with a combination of 3 different mesh sizes : 100 x 100, 100 x 50 and 50 x 50 mm. The double, alternating horizontal wires offer good rigidity.

The panels have a width of 2005 mm and are available in a range of heights from 655 till 2005 mm. Wire diameter of the horizontal wires: 5.00 mm, wire diameter of the vertical wires: 4.15 mm.

Posts and fixation



Bekaclip posts

Zenturo Classic panels can be installed with metal posts type Bekaclip (as used for Bekafor Classic panels). The panels can easily be fixed to the posts using standard Bekafor accessories.

Gates

The Zenturo Classic panel fence matches perfectly with the Zenturo Classic swing gates assortment.

Coating technique

The panels are made of galvanised wire, and an adhesion layer is provided for perfect adhesion with the polyester top coating (min. 100 micron).

The posts are internally and externally galvanised (min. layer thickness 275g/m², both sides combined) according to Euro standard EN 10346, after which an adhesion layer is applied and polyester plastic coated (min. 60 micron).



Colors

Metallic Anthracite BF7016M. Other colors on request.

Infills

The Zenturo Classic panel can be filled with 3 different, unique and decorative 'infills'. Note: use adapted post diameters when filling the panels completely with strips.



Pixels

Square and rectangular plastic elements perfectly fit into the panel's different mesh sizes: 100x100, 100x50 and 50x50 mm. The pixels are easily clicked on the panel and can be used to form different patterns on the fence... Available in anthracite.

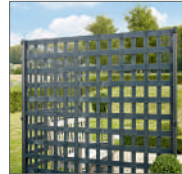

Flexo Strip

Flexible plastic strip is available in 2 widths (44 mm for mesh width 50 mm, 94 mm for mesh with 100 mm). They can be woven through the panel's meshes, both in vertical and horizontal direction. Available on rolls of 50 m (to be cut to length), in anthracite.

ASSORTMENT ZENTURO CLASSIC PANELS

Fence height mm	Size Panels width x height mm	Post length to be put in concrete* mm	Length of post to be put on base plate mm	Bekaclip posts number of collars per post*
655	2005 x 655	1100	700	2
955	2005 x 955	1500	1100	2
1255	2005 x 1255	1700	1300	3
1555	2005 x 1555	2000	-	3
1705	2005 x 1705	2300	-	4
2005	2005 x 2005	2500	-	4

ASSORTMENT ZENTURO CLASSIC INFILLS

Pixels width x length in mm Color: metallic anthracite	Flexo Strip width x roll length in mm x m Color: anthracite
100 x 100	44 x 50
100 x 50	94 x 50
50 x 50	-





Zenturo® Super Zenturo® Wall

Panels

Zenturo Super is a complete fencing solution with a high design content. The panels can be used as single panels or for the creation of gabion walls.

Product detail

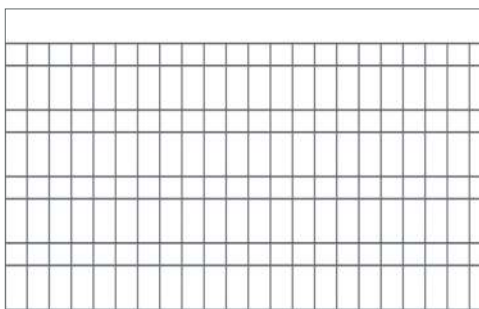

BENEFITS

Extremely high strength

Zenturo Super panels are exceptionally strong due to the narrower meshes (compared to Zenturo Classic panels).

Functional Design

Zenturo Super panels are stronger than Zenturo Classic, through the narrower meshes and thus making them ideally suited for gabion walls. In combination with the Zenturo post concept and associated spider fixators, a wide variety of infills can be used to create a personalised aesthetic look.

Easy installation

The Zenturo Super panels can be combined with the Bekaclip posts (to be mounted with collars) or the Zenturo post system (with spider fixators) for gabion walls.

Complete system

The complete Zenturo Super system consists of panels in 6 heights, to be installed with 2 types of posts with a specific fixation system, and a Zenturo Classic swing gate. In this way, you design your own unique, secure fencing system.

Security level



Applications

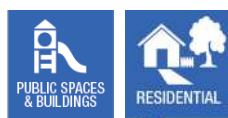

Functionalities



Panels

The Zenturo Super panels are flat panels with double (2D) alternating horizontal wires for added strength. The panels are 2005 mm wide and are available in heights from 655 mm up to 2005 mm.

Mesh sizes: 100x50 and 50x50 mm

Horizontal wire diameter: 5.00 mm

Vertical wire diameter: 4.15 mm

As a finishing touch, we have developed an extra panel (with wire diameter of 3.80 mm) which needs to be fixed at the top of the gabion wall (once the gabion wall has been filled up). It is available in anthracite (BF7016M).

Posts and fixing systems

Zenturo posts (available in concrete or on baseplate)

The Zenturo Post is a rectangular tube with a cross section of 120 x 40 mm and a wall thickness of 2.00 mm. Galvanised and polyester plastic coated.

Gates

The Zenturo Super system can easily be combined with the Zenturo Classic swing gate (single version).

Coating technique

The panels are made of galvanised wire, and an adhesion layer is provided for perfect adhesion with the polyester top coating (min. 100 micron).

The posts are internally and externally galvanised (min. layer thickness 275g/m², both sides combined) according to Euro standard EN 10346, after which an adhesion layer is applied and polyester plastic coated (min. 60 micron).

Colors

Anthracite grey BF7016M
Other colors upon request

Panel infills

The Zenturo Super panel can be personalized with different unique and modern infills:

Note: use adapted postdiameters when filling the panels completely with strips.



Pixels

These square and rectangular plastic elements perfectly fit into the panel's different mesh sizes: 100x50 and 50x50 mm. The pixels can be easily clicked on the panel and can be used to form numbers, words or patterns on the fence...

Available in metallic anthracite.



Flexo Strips

The Zenturo Super panels can be filled with the Flexo Strip. The flexible plastic strip is available in 2 widths (44 mm for mesh width 50 mm, 94 mm for mesh with 100 mm) and is woven through the panel's meshes, both in vertical and horizontal direction. Available on rolls of 50 m (to be cut to length), in anthracite.

The accessories can be fitted at time of installation or later. Zenturo Super allows you to update your style without changing the fence.

ASSORTMENT ZENTURO SUPER

Fence height mm	Panel dimensions width x height - mm	Length of Bekacclip post to be put in concrete* mm	Bekacclip posts - number of brackets per post*	Zenturo post concept post lengths 120x40 mm	Zenturo spider clips per post
655	2005 x 655	1100	2	1100	2 x 3
955	2005 x 955	1500	2	1500	2 x 4
1255	2005 x 1255	1700	3	1700	2 x 5
1555	2005 x 1555	2000	3	2000	2 x 6
1705	2005 x 1705	2300	4	2400***	2 x 7**
2005	2005 x 2005	2500	4	2700***	2 x 8**

* Only for installation of a Zenturo Super panel, straight fence with posts in concrete. For installation as a gabion wall, use only the Zenturo post concept.

** Extra inserts are foreseen to combine two panels on top of each other.

*** Check the installation instructions when using the panel as a gabion wall. (Zenturo brochure)

ASSORTMENT ZENTURO SUPER PANEL INFILL

Pixels W x H mm	Flexo Strips B mm x Roll length m	Perfo Strips W x H mm
50 x 50	44 x 50	44 x 1700 / 2000
100 x 50	94 x 50	-
Metallic anthracite	Anthracite	Natural stainless steel





Bekazur® 2D

Panels

Bekazur 2D is a panel system hindering access to swimming pools. Designed to specific standards, it is rigid, multi-functional and elegant.

Product detail



BENEFITS

Conformity

The system conforms to the French standard NF 90-306 designed to restrict the access to swimming pools for children younger than five years old. The standard defines the technical characteristics of the system and resistance to corrosion of all metallic parts.

Multi-functional

The installation of Bekazur is very simple. It can be installed on base plate or in concrete. Installation on sloping ground is also possible.

Elegance

The decorative topping makes the fence simple and aesthetic.

Security level



Applications



RESIDENTIAL

Functionalities



DEMARCATON

DESIGN

Panels

Bekazur 2D is a panel system welded out of rigid galvanised wires and then polyester coated afterwards.

The heavy diameter of the wires makes the panel highly resistant.

- Horizontal wires: 8,00 mm
- Vertical wires: 8,00 mm
- Distance between 2 vertical wires: 65 mm
- Minimum distance between 2 horizontal foot support points: 1100 mm

Posts



The panels can be installed with:
Round post diam. 48 x 1,50 mm with cap, galvanised and polyester coated white RAL 9010. Special brackets in polyamide are used for the fixation of the panel to the post.

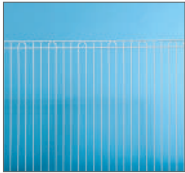

For installation on a concrete or tiled floor: an aluminium base plate, white polyester coated is available.

Coating technique

Panels are made out of galvanised wires. An adhesion coating is given for a perfect adhesion of the polyester coating (min. 100 micron).



Colors

White RAL 9010

Gates



Hot dipped galvanised + polyester coating.

- Adjustable stainless steel hinges
- Round posts d. 60 x 2.00 mm.
- Security locking system 'double action' (The gate can only be opened by 2 simultaneous and independent actions) + cylinder supplied with 3 keys.
- Options: automatic self-closing hinges, wich replace those supplied with the gates.



Gates available in 2 versions:

- with posts for installation in concrete
- post with base plate for installation on concrete surface or on tiles.

ASSORTMENT BEKAZUR 2D PANELS

Fence height mm	Dimensions panels W x H mm
1196	983 x 1196
1196	2023 x 1196
1396*	2023 x 1396

* For installation on slope ground

ASSORTMENT BEKAZUR 2D GATES

Height of the fence mm	Post length mm	Width gate mm (c/c)	Diameter Post mm
1196	1349	1215	60*
1196	1800	1215	60**

* With 2 posts diam. 60 x 2,00 mm with adapted base plates for installation on a concrete floor (4 collars diam. 60 mm included)

** With 2 posts diam. 60 x 2,00 mm : to put in concrete (4 collars diam. 60 mm included)

ASSORTMENT BEKAZUR 2D POSTS

Fence height mm	Post length mm	Installation type
1196	1250	base plate
1196	1600	concrete
1396	1450	base plate*
1396	1800	concrete*

* For installation on slope ground





CreaZen®

Panels

CreaZen is a completely new railing system with an attractive design, inspired by natural elements.

Product detail



BENEFITS

Stylish

This panel, with its criss-cross design of natural lines, is inspired by the current trend of decorative new style railings. A modern take on a classical concept.

Pure design

The square tubes of this particular fence panel provide a balanced aesthetic and a clean-cut look.

Sleek installation

This new panel retains its sleek exterior thanks to almost invisible fixings, and is also easy to install with our compatible range of Bekafix posts.

Security level

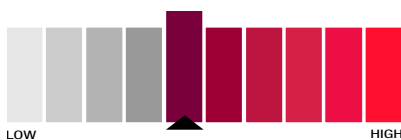

Applications



Functionalities





Panels

The panels have a width of 2400 mm and are available in a range of heights from 1000 to 2000 mm.

The vertical square tubes are welded at both sides of the horizontal tubes, in a criss-cross way.

Spacing between the vertical tubes is max. 110 mm

Horizontal rectangular tubes: 40 x 20 mm

Vertical square tubes: 20 x 20 mm

Posts and fixation



Bekafix posts

CreaZen panels are installed with Bekafix and Bekafix Ultra posts. They are easily fixed to the posts by making use of specific fixators.

Gates

CreaZen fences can be combined with CreaZen gates, available as a single and double swing gates.

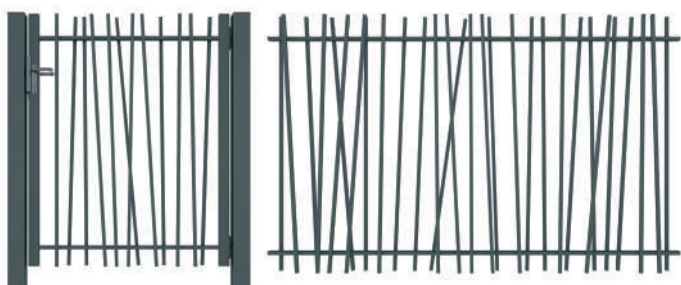

Coating technique

The welded panel is hot dip galvanized and polyester coated (min 60 micron). The Bekafix posts are galvanized inside and out and polyester coated (min. 60 micron).

Accessories

Several installation accessories are available:

- fixation clamps (plastic), with stainless steel nuts and bolts
- base plates
- corner fixators for installing panels in an angle
- closing caps for vertical tubes
- Bekafix flat caps without hook

Colors

Anthracite RAL 7016

Other colors on request

ASSORTMENT CREAZEN

Fence height mm	Dimensions panels (width x height) mm	Height post to be put in concrete mm	Height post combined with base plate mm	Number of fixings per post
1000	2400 x 1000	1475	1075	4
1200	2400 x 1200	1675	1275	4
1500	2400 x 1500	1975	1575	4
1700	2400 x 1700	2175	1775	4
2000	2400 x 2000	2575	2075	4





Decofor®

Panels

The Decofor system is a complete decorative fencing system developed for design oriented and rigid fencing solutions.

Product detail

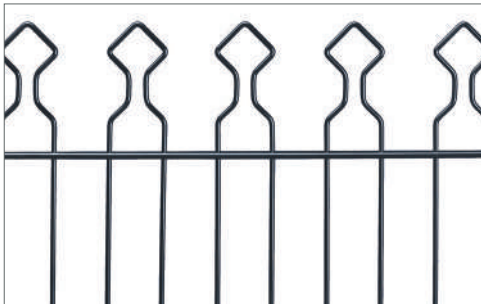

BENEFITS

Decorative

Decofor is a professional fence with a unique contemporary design. The panels are robust and yet extremely elegant and decorative. The panels, posts and gates are perfectly harmonised.

High longevity

Betafence's coating technology is state of the art and guarantees a high longevity. After galvanising an adhesion coating is applied for a perfect bond with the final polyester coating.

Easy installation

The system is easy to install. All elements are precisely integrated. The Decofor system allows installation between and on walls.

Complete system

There are 2 types of Decofor: Arco (convex) and Recto (flat panels). They all exist in different heights, with accompanying posts, swing gates (single or double) and installation accessories. All of one uniform design.

Security level



Applications

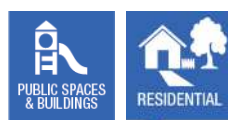

Functionalities

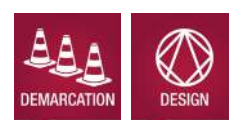

Panels

The panels are 2015 mm wide and available in 4 heights. The mesh size is 200 x 65 mm. The wires are very strong: horizontal double wires 8 mm and vertical 6 mm.

Gates

The Decofor fencing system can easily be combined with single and double Decofor gates.

Coating technique

Panels, posts and gates are first galvanised. Afterwards an adhesion coating is applied for perfect bond with the final polyester coating. The minimum coating thickness is 100 micron (panels) and 60 micron (posts and gates).

Colors

Decofor Arco: available in black (RAL 9005).
Decofor Recto and other colors: available on request.



Posts and fixing systems



The posts are welded square tubular posts with profile of 60 x 60 x 1,50 mm. For a decorative design the posts are supplied with a metal cap with ball.

Fixation of the panels to the posts by means of metal fixing collars (galvanised and plastic coated) and with security bolts M8 out of stainless steel with self breaking nut.

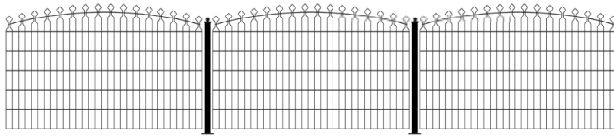

Decofor Arco

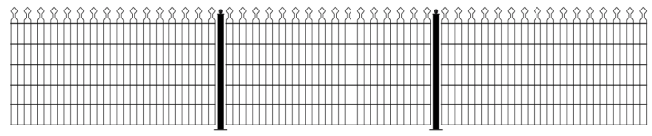

Decofor Recto

ASSORTMENT DECOFOR PANELS AND POSTS WITH CAP WITH BALL

Decofor Arco width x height (middle of the panel) mm	Decofor Recto width x height mm	Post length mm		Number of collets per post
		Posts to be put in concrete	Post welded base plate	
2015 x 886	2015 x 762	1500	965	2
2015 x 1086	2015 x 962	1500	1165	3
2015 x 1286	2015 x 1162	1750	1365	3
2015 x 1486	2015 x 1362	2000	1565	3





Nylofor® 3D

Panels

The Nylofor 3D system is the reference panel on the market. This complete fencing system provides optimal protection, with style.

Product detail



BENEFITS

Rigidity

Panels with rectangular meshes, heavy wires and horizontal curves guarantee a very high level of rigidity.

Complete system

The system consists of panels in various heights supported by 5 types of posts, each with a specific fixing system. All types are available with adapted accessories and a wide range of swing and sliding gates.

Long lifetime

Betafence's coating technology is state of the art and assures an extra long life. A special layer is applied after galvanisation to ensure optimal adhesion of the polyester top coat.

Efficient and fast installation

All components have been developed to provide a professional system that can be installed efficiently and rapidly.

Security level



Applications



Functionalities



Post and fixing systems



Nylofor - Twifix post system

The panels are fixed on the front side of the posts by means of fixators and security bolts. The welded square tubular posts (60 x 60 mm) have inserts for fixing the panels and are covered with a plastic cap. For installation higher than 2.40 m, post section can be 80x60 or 120x60



Bekafix and Bekafix Ultra post system

The panels are fixed laterally onto the posts and secured with anti-vandal metal security fixators. The H-shape welded tubular posts (70 x 44 mm), are galvanised, PES coated and supplied with a polyamide cap and accessories.



Izifix post system

Lateral fixing of the Nylofor 3D panels in the Izifix post, without accessories. Perfect fixing of the curves of the panel in the post profile. The Izifix posts (75 x 50 mm + slots every 100 mm) are covered with a plastic cap.



E-LOX post system

E-LOX posts (60 x 40 mm) are typical for endless installation. They are covered on top with a hard plastic cap.

For technical details on different post systems: cfr. specific pages on posts.

Panels

The panels have a width of 2500 mm and a height from 630 to 2430 mm. The panels have vertical barbs of 30 mm on one side and are reversible (barbs at top or at bottom). Mesh sizes are 200 x 50 mm, and 100 x 50 mm for the beam sections. The heavy wires, with a diameter of 5 mm guarantee a high level of rigidity.

Gates

The Nylofor 3D system is complete and optimal protection is given using the high technology Robusta swing and sliding gate.

Coating technique

Panels made out of galvanised wires. An adhesion coating is given for a perfect adhesion with the polyester coating (min. 100 micron).



Colors

Nylofor 3D is standard available in green RAL 6005 - white RAL 9010 - black RAL 9005 - grey RAL 7016. More and other colors out of our RAL Collection are available on request.

ASSORTMENT NYLOFOR 3D

Fence height mm	Panels width x height mm	Number of curves per panel
630	2500 x 630	2
830	2500 x 830	2
1030	2500 x 1030	2
1230	2500 x 1230	2
1530	2500 x 1530	3
1730	2500 x 1730	3
1930	2500 x 1930	3
2030	2500 x 2030	4
2430	2500 x 2430	4





Nylofor® 3D Super

Panels

The Nylofor 3D Super system with specific 3D bend and very thick horizontal wires provides optimal protection and offers a unique design.

Product detail



BENEFITS

Very high Rigidity

The panels are extremely rigid due to the large wire diameters and the use of a specific 3D bend.

High degree of security

Nylofor 3D Super is the recommended fencing system when security is crucial.

Long lifetime

Betafence's coating technology guarantees a high longevity. After galvanising, a special layer is applied for a perfect adhesion of the polyester coating.

Complete system

The system offers panels in different heights, posts with adapted fixation systems and a large range of gates. All components guarantee a fast and professional installation.

Security level



Applications



Functionalities



Post and fixing systems

The Nylofor 3D Super system can be used with several posts systems:



Nylofor - Twifix post system

The panels are fixed on the front side of the posts by means of fixators and security bolts. The welded square tubular posts (60 x 60 mm) have inserts for fixing the panels and are covered with a plastic cap. For installation higher than 2.40 m, post section can be 80x60 or 120x60.

Square post system with bent arm: possible



Bekafix and Bekafix Ultra post system (with metal fixators)

The panels are fixed laterally onto the posts and secured with anti-vandal metal security fixators. The H-shape welded tubular posts (70 x 44 mm), are galvanised and PES coated an supplied complete with a polyamide cap and accessories.

For technical details on different post systems: cfr. specific pages on posts.

Panels

Heavy welded mesh, 2500 mm wide and available in different heights.

The panels have vertical barbs of 30 mm height on one side.

Standard mesh: 200 x 50 mm

Mesh of 3D bend: 200 x 50 mm

Wire diameter:

Horizontal: 8.00 mm

Vertical: 5.00 mm

Gates

The Nylofor 3D Super system is completed by the Robusta swing and sliding gates and Bekamatic gates.

Coating technique

The panels are made out of galvanised wires. An adhesion coating is given for a perfect adhesion with the polyester coating (min.100 micron).



Colors

Nylofor 3D Super is standard available in green RAL 6005

More and other colors out of our RAL Collection are available on request.

ASSORTMENT NYLOFOR 3D SUPER

Fence height mm	Panels width x height mm	Number of curves per panel
1030	2500 x 1030	2
1630	2500 x 1630	3
2030	2500 x 2030	4
2430	2500 x 2430	4
3030	2500 x 3030	4

Other heights available on request





Nylofor® 3D Pro / 3D Pro XL

Panels

Nylofor 3D Pro is a high quality fencing system developed for an efficient installation and long life time.

Product detail

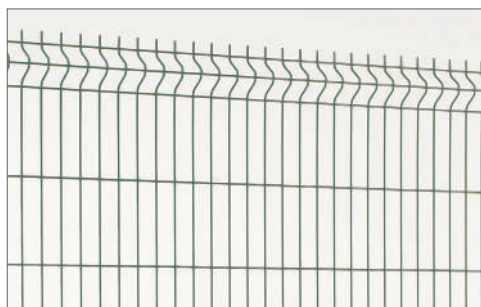

BENEFITS

High longevity

Betafence's coating technology is state of the art and assures an extra long life. A special layer is applied after galvanization to ensure total adhesion of the PVC top coat.

Excellent price/quality rate

Nylofor 3D Pro is a rigid and quality product offered at an attractive price. The extra long Nylofor Pro XL panels (3 meters) in combination with the Quixolid Plus posts without accessories, guarantee more than a double price advantage preserving quality and rigidity.

XL version for fast installation

Because of the 3 meter long panels, the Nylofor 3D Pro XL panels are very fast and convenient to install.

Rigidity

Heavy welded mesh panels with rectangular meshes and horizontal curves guarantee a high level of rigidity.

Security level

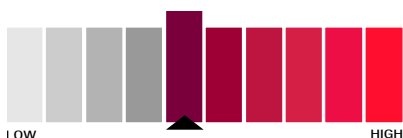

Applications



Functionalities

Post and fixing systems



Nylofor - Twilfix post system

The panels are fixed on the front side of the posts by means of fixators and security bolts. The welded square tubular posts (60 x 60 mm) have inserts for fixing the panels and are covered with a plastic cap. For installation higher than 2.40 m, post section can be 80x60 or 120x60



Bekafix and Bekafix Ultra post system

The panels are fixed laterally onto the posts and secured with anti-vandal metal security fixators. The H-shape welded tubular posts (70 x 44 mm), are galvanised and PES coated and supplied complete with accessories and a polyamide cap.



Izifix post system

Lateral fixing of the Nylofor 3D Pro (XL) panels in the Izifix post, without accessories. Perfect fixing of the curves of the panel in the post profile. The Izifix posts (75 x 50 mm + slots every 100 mm) are covered with a plastic cap.

For technical details on different post systems: cfr. specific pages on posts.

Panels

The Nylofor 3D Pro panels have a width of 2500 mm and are available in a range of heights: from 630 to 2430 mm. The Nylofor 3D Pro XL panels have a width of 3000 mm and a height from 1230 to 2430 mm. The panels of both systems have vertical barbs of 30 mm at one side, the barbs can be placed at the top or at the bottom. The horizontal curves give the panels extra rigidity. The meshes are 200 x 50 mm, meshes at the curves 100 x 50 mm. The wire diameter is 5 mm.

Gates

The panels can easily be combined with Robusta swing- and sliding gates.

Coating technique

The panels are made out of galvanised wires. A pre-treatment process guarantees a perfect PVC-coating adhesion to the product surface.



Colors

Nylofor 3D Pro panels are available in green RAL 6005, white RAL 9010 and grey RAL 7016. Nylofor 3D Pro XL is standard available in green RAL 6005 and black RAL 9005.

ASSORTMENT NYLOFOR 3D PRO/ 3D PRO XL

Fence height mm	Panels width x height mm		Number of curves per panel
	Nylofor 3D Pro	Nylofor 3D Pro XL	
630	2500 x 630		2
830	2500 x 830		2
1030	2500 x 1030		2
1230	2500 x 1230	3000 x 1230	2
1530	2500 x 1530	3000 x 1530	3
1730	2500 x 1730	3000 x 1730	3
1930	2500 x 1930	3000 x 1930	3
2030	2500 x 2030	3000 x 2030	4
2430	2500 x 2430	3000 x 2430	4





Nylofor® 3D Light II

Panels

Nylofor 3D Pro Light II is a panel with horizontal profiling that increases the rigidity of the fence.

Product detail



BENEFITS

Long-term use

Betafence's coating technology is now among the most modern in the world, thanks to three layers: zinc, primer and polyester coating.

Quick installation

All elements composing our fencing system are designed to provide professional, easy and quick system installation.

High rigidity

Welded panels with rectangular meshes and horizontal profiling make the fence deformation-resistant.

Complete system

The system consists of panels, posts, gates and the necessary accessories. There are several choices types of posts and a wide range of wing and sliding gates

Security level



Applications



Functionalities

Post and fixing systems



Nylofor - Twilfix post system

The panels are fixed on the front side of the posts by means of fixators and security bolts. The welded square tubular posts (60 x 60 mm) have inserts for fixing the panels and are covered with a plastic cap. For installation higher than 2.40 m, post section can be 80x60 or 120x60



Bekafix and Bekafix Ultra post system

The panels are fixed laterally onto the posts and secured with anti-vandal metal security fixators. The H-shape welded tubular posts (70 x 44 mm), are galvanised and PES coated an supplied complete with accessories and a polyamide cap.

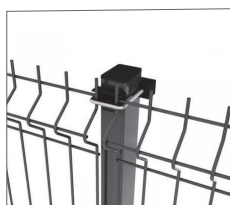

Rectangular Nylofor post system

For medium security applications and cost efficiency: front fixing of the panels with specific collets. Welded tubular posts (60 x 40 mm) ended on the top with a plastic cap



Izifix post system

Lateral fixing of the Nylofor 3D Light II panels in the Izifix post, without accessories. Perfect fixing of the curves of the panel in the post profile. The Izifix posts (75 x 50 mm + slots every 100 mm) are covered with a plastic cap.

For technical details on different post systems: cfr. specific pages on posts.

Panels

The Nylofor 3D Light II panels have a width of 2500 mm and are available in a range of heights: from 1030 to 2030 mm.

The panels have vertical barbs of 30 mm at one side, the barbs can be placed at the top or at the bottom.

The horizontal curves give the panels extra rigidity.

The meshes are 200 x 50 mm, meshes at the curves 100 x 50 mm.

The wire diameter is 4 mm.

Gates

The panels can easily be combined with Robusta swing and sliding gates.

Coating technique



The panels are made out of galvanised wires. Applied surface preparation process ensures excellent adhesion of the polyester coating to the ground. The thickness of the polyester coating is min. 100 micrometers.

Colors

Nylofor 3D Light II panels are available in green RAL 6005, black RAL 9005 and grey RAL 7016.

We can also supply you these panels in hot deep galvanized finition.

Other colors are possible on request.

ASSORTMENT NYLOFOR 3D LIGHT II

Fence height mm	Panels width x height mm	Number of curves per panel
1030	2500 x 1030	2
1230	2500 x 1230	2
1530	2500 x 1530	3
1730	2500 x 1730	3
2030	2500 x 2030	4



Nylofor® 3D Essential

Panels

Nylofor 3D Essential is a quality and long lifetime fencing system with panels of 2.5 metres wide, designed for a professional and low-cost installation.

Product detail



BENEFITS

Longevity

The coating technology of Betafence is state-of-the-art and assures a long lifetime. A special layer is applied after galvanization to ensure total adhesion of the PVC coating.

Excellent price/quality rate

Nylofor 3D Essential provides good quality and rigidity at a low cost.

Complete system

The system consists of panels in various heights, installed on square Nylofor, Bekafix or Quixolid Plus posts, with a specific fixing system. A wide assortment of innovative swing and sliding gates completes the fence system.

Security level



Applications



Functionalities





Bekafix and Bekafix Ultra post system

The panels are fixed laterally on the posts with specific fixators made out of polyamide or metal (security).

The welded tubular posts (70 x 44 mm), in H-shape are covered with a plastic cap.



Izifix post system

Lateral fixation of the Nylofor 3D Essential panels to the Izifix posts without specific accessories. The panels are held perfectly in the post profile. The Izifix posts (75 x 50 mm + slots every 100 mm) are supplied with a plastic cap.



Nylofor - Twilfix post system

The panels are fixed on the front side of the posts by means of fixators and security bolts. The welded square tubular posts (60 x 60 mm) have inserts for fixing the panels and are covered with a plastic cap. For installation higher than 2.40 m, post section can be 80x60 or 120x60



E-Lox post system

The panels are fixed to the front of the rectangular post by means of hook screws in M8 with break-off nuts.

The welded rectangular posts (60 x 40 x 2 mm) have pre-drilled holes for fixing the hook screws and are supplied with a plastic cap.

Panels

The panels have a width of 2500 mm and are available in a range of heights, from 1030 to 1930 mm. The panels have vertical barbs of 30 mm at one side, the barbs can be placed at the top or at the bottom.

The horizontal reinforcements give the panels extra rigidity.

Mesh dimensions: 200 x 50 mm

Mesh at reinforcements: 100 x 50 mm

Horizontal wire diameter: 5 mm

Vertical wire diameter: 4 mm

Gates

The Nylofor 3D Essential is totally finished and safely equipped with high tech gates: Type Nylofor or Robusta single and double swing gates and sliding gates.

Coating technique

Panels are made out of galvanized wires. A pre-treatment guarantees a perfect PVC coating adhesion to the product surface.



Colors

Green RAL 6005

Anthracite RAL 7016

ASSORTMENT NYLOFOR 3D ESSENTIAL

Fence height mm	Dimensions panels (width x height) mm	Number of noses per panel
1030	2500 x 1030	2
1230	2500 x 1230	2
1530	2500 x 1530	3
1730	2500 x 1730	3
1930	2500 x 1930	3



Nylofor® F

Panels

The Nylofor F system consists of heavy welded mesh fence panels with horizontal flat wires providing maximum rigidity and an original design.

Product detail



BENEFITS

High rigidity

The 15 x 6 mm horizontal flat wires provide high rigidity to the panels.

Modern look

The use of Nylofor F panels with flat horizontal wires is modern and at the same time very robust.

Long lifetime

The high quality of the coating ensures a long lifetime. After being zinc coated, the products are protected by a polyester coating with a perfect adhesion.

Quick installation

The different post systems of Nylofor F guarantee a quick and professional installation.

Complete & versatile system

The Nylofor F system is a professional system with panels of different heights, in combination with several types of posts and a wide assortment of swing and sliding gates of the type Robusta.

Security level



Applications



Functionalities



Post and fixing systems



Nylofor - Twilfix post system

The panels are fixed on the front side of the posts by means of fixators and security bolts. The welded square tubular posts (60 x 60 mm) have inserts for fixing the panels and are covered with a plastic cap. For installation higher than 2.40 m, post section can be 80x60 or 120x60



Bekafix and Bekafix Ultra post system

The panels are fixed laterally onto the posts and secured with anti-vandal metal security fixators. The H-shape welded tubular posts (70 x 44 mm), are galvanised and PES coated and supplied complete with a polyamide cap and accessories.



E-LOX system

Welded rectangular tubular posts (60 x 40 x 1,5 mm) with pre-drilled holes for fixing the corresponding screw hooks M8 with snap-off nut and plastic cap. A flexible post distance results in a fast installation.



D-LOX post system

The panels are fixed on to the front side of the posts, they are first hung in the premounted metal clamps.

Panels

The panels are 2500 mm width and in a range of heights: 630 to 2430 mm. The mesh dimensions are 200 x 50 mm. The panels have barbs of 30 mm on top. The galvanised wires are extra heavy: the horizontal wires are 15 x 6 mm, the vertical wires have a diameter of 5 mm.

Gates

The Nylofor F system is completed by the secure and high technology gates type Robusta: single or double swing or sliding gates.

Coating technique

Panels made out of galvanised wires. An adhesion coating is given for a perfect adhesion with the polyester coating (min. 100 micron).



Colors

Green RAL 6005 and RAL 7016.
Other RAL colors on request.

ASSORTMENT NYLOFOR F

Height fence mm	Dimensions panels width x height - mm
630	2500 x 630
830*	2500 x 830
1030	2500 x 1030
1230	2500 x 1230
1430	2500 x 1430
1630	2500 x 1630
1830	2500 x 1830
2030	2500 x 2030
2230	2500 x 2230
2430	2500 x 2430

* not available in green RAL 6005





Nylofor® City

Panels

Nylofor City is a heavy welded mesh fence with horizontal flat wires and a top rail for extra rigidity and a sophisticated look.

Product detail



BENEFITS

High rigidity

The top rail gives extra rigidity to the panels and is ideal for use in public access areas.

Robust look

The use of Nylofor F panels with flat horizontal wires is modern and at the same time very robust.

Easy installation

The top rails are easy to fix to the panels and posts due to special accessories. Installation of the system with base plates is also foreseen.

Security level



Applications



Functionalities



Panels

The panels used for the Nylofor City system are Nylofor F panels. They are 2500 mm width and of different heights: 630 to 2030 mm. Mesh sizes are 200 x 50 mm. The wires are extra heavy: the horizontal wires are 15 x 6 mm, the vertical wires have a diameter of 5 mm.

Post and fixing systems



Square posts (60 x 60 mm) out of welded tube. The posts are provided with inserts for fixing the Nylofor F panels. The posts have a plastic cap.

Accessories

- Fixing clips in polyamide**
 For the connection of two panels on one post.
- Security bolt M8**
 To secure the fixing clips in the inserts of the posts.
 Made of stainless steel.
 Length: 40 mm; length 60 mm for the top insert.
 With domed head, M8, inner hexagon.
- Support profile**
 Profile C 31,5 x 32,5 x 1,50 mm.
 Galvanised and plastic coated (polyester). Length 2505 mm.

Fixators for support profile

Type C 33 x 39 x 50 mm

For the fixing of two support profiles on the intermediate post.

Type C 33 x 39 x 54 mm

For the fixing of a support profile on the end post: a left clip for the left end post and a right clip for the fixing on the right end post.

For the fixing of two support profiles on a corner post: a right and a left clip.

Steel fixators with 8 mm diameter holes. Galvanised and plastic coated (polyester).

Options

Neoprene anti-vibration strips

To reduce noise and eliminate vibration between fence panels and support profile. Self adhesive, length 25 mm. Fixed to the top horizontal wire of the panel.

Coating technique

Panels made out of welded galvanised wires. An adhesion coating is given for a perfect adhesion with the polyester coating (min. 100 micron).



Colors

Nylofor City system is available in green RAL 6005 - white RAL 9010. More and other colors out of our RAL Collection are available on request.

ASSORTMENT NYLOFOR CITY

Fence height mm	Panel dimensions width x height mm	Nylofor posts to be anchored in concrete				Nylofor posts with base plate in aluminium			
		Quantity				Quantity			
		Post length mm	Inserts	Fixing clips steel	Fixing clips polyamide	Post length mm	Inserts	Fixing clips steel	Fixing clips polyamide
630	2500 x 630	1000	3	1	2	672	3	1	2
1030	2500 x 1030	1500	3	1	2	1072	3	1	2
1230	2500 x 1230	1750	4	1	3	1272	4	1	3
1430	2500 x 1430	2000	4	1	3	1472	4	1	3
1630	2500 x 1630	2200	5	1	4	1672	5	1	4
1830	2500 x 1830	2400	5	1	4	1872	5	1	4
2030	2500 x 2030	2650	6	1	5	2072	6	1	5

* For corner post: x2





Nylofor® 2D

Panels

The Nylofor 2D are welded mesh panels with double horizontal wires providing high rigidity.

Product detail



BENEFITS

Very rigid

The panels are rigid thanks to the use of welded mesh in conjunction with double horizontal wires.

Long lifetime

Betafence's coating technology guarantees a long lifetime. After galvanising an adhesion coating is applied for a perfect bond with the polyester coating.

Complete system

The system includes panels in different mesh apertures and heights, posts with adapted fixing systems and a large range of gates. All components guarantee a fast and professional installation.

Security level



Applications



Functionalities



Post and fixing systems

The Nylofor 2D system can be used with several posts systems:



Nylofor - Twilfix post system

The panels are fixed on the front side of the posts by means of fixators and security bolts. The welded square tubular posts (60 x 60 mm) have inserts for fixing the panels and are covered with a plastic cap.

For installation higher than 2.40 m, post section can be 80x60 or 120x60



Bekafix and Bekafix Ultra post system

The panels are fixed laterally onto the posts and secured with anti-vandal metal security fixators. The H-shape welded tubular posts (70 x 44 mm), are galvanised and PES coated and supplied complete with a polyamide cap and accessories.



D-LOX post system

The panels are fixed on to the front side of the posts, they are first hung in the premounted metal clamps.



O-LOX post system

Rigid post system with coverplate or stainless steel fixing plate.

Panels

The panels have a width of 2500 mm and a height from 630 to 2430 mm.

The panels have vertical barbs of 30 mm on one side and are reversible (barbs at top or at bottom).

Type	Wire diameter		Mesh
	Horizontal	Vertical	
Nylofor 2D	2 x 6 mm	5 mm	200 x 50

Gates

The Nylofor 2D system can be completed with Robusta type gates: single or double swing or sliding gates.

Privacy system available

Nylofor 2D panels can be filled with Screeno Wave for a full privacy solution.

Coating technique

Panels made out of galvanised wires. An adhesion coating is given for a perfect adhesion with the polyester coating (min. 100 micron).



Colors

Nylofor 2D is available in green RAL 6005, grey RAL 7016.

Other RAL colors are available on request.

ASSORTMENT NYLOFOR 2D

Fence height - mm	Panels width x height - mm
630	2500 x 630
830	2500 x 830
1030	2500 x 1030
1230	2500 x 1230
1430	2500 x 1430
1630	2500 x 1630
1830	2500 x 1830
2030	2500 x 2030
2430	2500 x 2430





Nylofor® 2D Super

Panels

The Nylofor 2D Super is a welded mesh panel with extra heavy double horizontal wires providing very high rigidity

Product detail



BENEFITS

Very rigid

The panels are rigid thanks to the use of welded mesh in conjunction with extra heavy double horizontal wires.

High degree of security

Nylofor 2D Super are recommended as fencing systems for applications where security is crucial, because of the small mesh and the heavy wires.

Long lifetime

Betafence's coating technology guarantees a long lifetime. After galvanising an adhesion coating is applied for a perfect bond with the polyester coating.

Complete system

The system includes panels in different mesh apertures and heights, posts with adapted fixing systems and a large range of gates. A large assortment of standard colors is available.

Security level



Applications

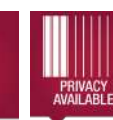

Functionalities

Post and fixing systems



Nylofor - Twilfix post system

The panels are fixed on the front side of the posts by means of fixators and security bolts. The welded square tubular posts (60 x 60 mm) have inserts for fixing the panels and are covered with a plastic cap. For installation higher than 2.40 m, post section can be 80x60 or 120x60



Bekafix and Bekafix Ultra post system

The panels are fixed laterally onto the posts and secured with anti-vandal metal security fixators. The H-shape welded tubular posts (70 x 44 mm), are galvanised and PVC coated and supplied complete with a polyamide cap and accessories.



D-LOX post system

The panels are fixed on to the front side of the posts, they are first hung in the premounted metal clamps.



O-LOX post system

Rigid post system with cover plate or stainless steel fixing plate.

Panels

The panels have a width of 2500 mm and a height from 630 to 2430 mm. The panels have vertical barbs of 30 mm on one side and are reversible (barbs at top or at bottom).

Type	Wire diameter		Mesh
	Horizontal	Vertical	mm
Nylofor 2D Super	2 x 8 mm	6 mm	200 x 50

Gates

The Nylofor 2D Super system can be completed with Robusta single or double swing or sliding gates and Bekamatic gates.

Privacy system available

Nylofor 2D Super panels can be filled with Screen Wave for a full privacy solution

Coating technique

Panels made out of galvanised wires. An adhesion coating is given for a perfect adhesion with the polyester coating (min. 100 micron).



Colors

Nylofor 2D Super is available in green RAL 6005, grey RAL 7016, black RAL 9005, green RAL 6009.

Other RAL colors are available on request.

ASSORTMENT NYLOFOR 2D SUPER

Fence height - mm	
630	2500 x 630
830	2500 x 830
1030	2500 x 1030
1230	2500 x 1230
1430	2500 x 1430
1630	2500 x 1630
1830	2500 x 1830
2030	2500 x 2030
2230	2500 x 2230
2430	2500 x 2430





Securifor®

Panels

Securifor is a high security fencing system made of anti-climb welded panels supported by the choice of high security posts.

Product detail

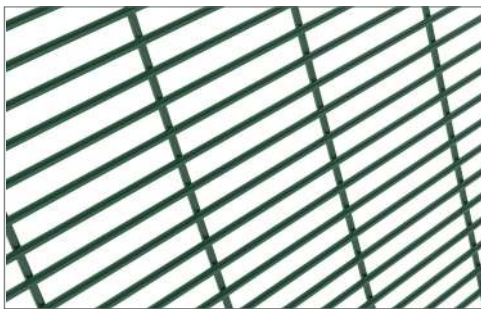

BENEFITS

Vandal resistant

The finger-proof aperture combined with 4mm wire diameter provides a substantial barrier that is difficult to climb and break through, almost impossible to cut wires with the use of conventional bolt or wire cutters.

Secure and discreet

The ultimate system for providing a high degree of security where a discreet visual impact on the immediate environment is essential.

Efficient deterrence

An effective deterrent to intruders available in various heights up to 6m - specially designed for high security applications. Compatible with electronic alarm and detection systems.

Durable

Low maintenance and long life resulting from high quality coating.

Complete system

Supplied as a complete system with panels, three possible post systems and gates. Installation on a slope is also available.

Security level



Applications



Functionalities

Post and fixing systems

Securifor can be installed with three different post types:



Rectangular post system

80 x 60 x 2,5 mm or 120 x 60 x 3,0 mm (depending on the post length). The posts have a single row of M8 threaded inserts. The panels are fixed using specific fixators or full length cover plates and one-way bolts.



Bekafix Ultra post system

Lateral fixing of the panels with special metal security clips with bolts. Welded tubular posts (70 x 44 mm) in H-shape with punched holes for positioning/fixing of the panels. Panels are fixed lateral on this post, with spider fixators and one way bolts. Posts are provided with a plastic cap.



Bekasecure post system

Post profile is 140 x 135 x 4 mm. They have a double range of holes 10 x 20 mm and the panels are secured with a continuous cover plate and specific stainless steel security bolts. The open profile of the post (patented) allows for electrical or fibre optic cabling and is closed with specific metal cap.

The top of the panels must be reinforced with a U-profile, available in steel (to be fixed with bolts) or in aluminium (clippable - see pictures above).

Panels

The panels are made of heavy, high security welded mesh of 2518,6 mm width. Several panels can be installed one above the other. Panels in one piece up to 6 m high are also available.

For maximum security the mesh is: 12,7 x 76,2 mm (H x W), with a 4 mm wire diameter.

Weld strength: 50% of the minimum tensile strength of the wire.

In tests, performed by specialised police departments, the mesh had a delay factor 40x greater than other standard fence products - a vital requirement to capture potential escapees.

Fully tested to comply with the security standards in Europe.

Gates

The Securifor system is supplied with matching gates using the same high security mesh infill as the fence. Single or double swing or sliding gates.

Coating technique

Panels made out of galvanised wires. An adhesion coating is given for perfect bonding with the polyester coating (min. 100 micron). The panels are also available coated in Zinalu Super (95% zinc, 5% aluminium) or galvanised and polyester coated for long life protection.



Colors

Green RAL 6005. Other RAL colors & Zinalu Super finishing are available on request.

Extra Security



Securifor Double Skin - panels

- guarantee a higher security and a maximum delay factor.
- two Securifor panels welded towards each other in an angle of 90°

ASSORTIMENT SECURIFOR

Height fence mm	Dimensions of the panels L x H - mm
2000	2518,6 x 2010,6
2400	2518,6 x 2417,0
3000	2518,6 x 3001,2
3650	2518,6 x 3674,3
4000	2518,6 x 4004,5
6000	2518,6 x 6011,1

* cfr. installation guide: available on request

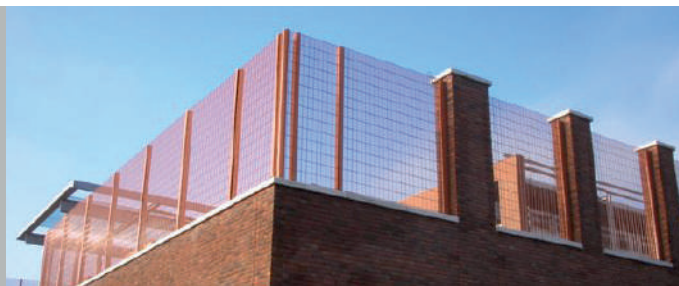



Securifor® 2D

Panels

The Securifor 2D system uniquely developed to combine very high rigidity and security with an aesthetic design.

Product detail

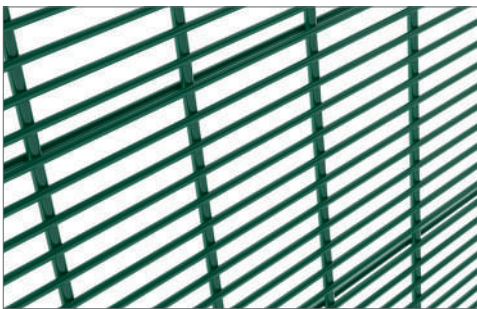

BENEFITS

Secure

Securifor 2D is the ultimate heavy weld-mesh panel for providing the highest degree of security. The rigidity of the panels is further obtained by the inclusion of 6 mm vertical wires and the addition of double 4 mm horizontal wires each 152,4 mm at the inside face of the panel. This product is ideally suited for applications that require high rigidity and where trespassing is prohibited.

Vandal resistant

The finger-and-toe-proof mesh profile combines an anti-climb and anti-cut panel with excellent visibility and resistance to vandalism. The small mesh apertures with heavy wires results in long delay times when using basic hand tools to attempt cutting through the panel.

Discreet

Minimal visual impact on the environment with excellent see through visibility, essential for use with security cameras.

Durable

Low maintenance and long life resulting from high quality coating.

Security level



Applications



Functionalities

Post and fixing systems

Securifor 2D can be installed with three different post types:



Rectangular post system

80 x 60 x 2,5 mm or 120 x 60 x 3,0 mm (depending on the post length). The posts have a single row of M8 threaded inserts. The panels are fixed using specific fixators or full length cover plates and one-way bolts.



Bekafix Ultra post system

Lateral fixing of the panels with special metal security clips with bolts. Welded tubular posts (70 x 44 mm) in H-shape with punched holes for positioning/fixing of the panels. Panels are fixed lateral on this post, with special spider fixators and one way bolts. Posts are provided with a plastic cap.



Bekasecure post system

Post profile is 140 x 135 x 4 mm. They have a double range of holes 10 x 20 mm and the panels are secured with a continuous cover plate and specific stainless steel security bolts. The open profile of the post (patented) allows for electrical or fibre optic cabling and is closed with specific metal cap.

Panel Securifor 2D

Mesh pattern (H x W):

12,7 mm x 76,2 mm welded at each intersection

Horizontal wires: 4 mm diameter at 12,7 mm and intermittent 4 mm double wires at 152,4 centres on the inside face.

Vertical wires: 6 mm diameter.

Weld strength:

- 50% of the minimum tensile strength of the wire

- Tensile range 540-690 N/m²

Coating technique

Panels made out of galvanised wires. An adhesion coating is given for perfect adhesion with the polyester coating (min. 100 micron).

Colors

Green RAL 6005.

Other RAL colors are available on request.



ASSORTMENT SECURIFOR 2D

Fence height mm	Panel size width x height - mm
2 000	2514,6 x 1981,2
2 400	2514,6 x 2438,4
3 000	2514,6 x 3048,0
4 000	2514,6 x 3962,4
6 000	2514,6 x 6007,1





Securifor® 3D

Panels

The Securifor 3D system is a complete system developed to combine high security and aesthetic design.

Product detail



BENEFITS

High security

The panels are heavy welded mesh with small rectangular apertures. Because of the large wire diameter (4 mm) and the restricted size of mesh (12,7 x 76,2 mm) Securifor 3D offers maximum security.

Attractive design

The horizontal bends make the Securifor 3D system ideally suitable for an environment where security and aesthetics go hand in hand.

Long lifetime

Betafence's coating technology is state of the art and guarantees a high longevity.

Good visibility

In spite of the small mesh aperture the see-through characteristics remain unimpaired when viewed head-on and even at an angle to the fence. This is particularly important for clear camera surveillance.

Complete system

Supplied as a complete system with panels, 2 possible post systems and gates. Installation on a slope is also available.

Security level



Applications



Functionalities



Panel

The panels are heavy welded mesh, provided with horizontal curves.
 Width: 2518,6 mm.
 Mesh sizes: 12,7 x 76,2 mm (H x W).
 Wire diameter: 4 mm.

Coating technique

Panels made out of galvanised wires. An adhesion coating is given for a perfect adhesion with the polyester coating (min. 100 micron).

Colors

Green RAL 6005.
 Other colors are available on request.

Post and fixing systems



Bekafix Ultra post system

Lateral fixing of the panels with special metal security clips with bolts. Welded tubular posts (70 x 54 mm) in H-shape with punched holes for positioning/fixing of the panels. Panels are fixed lateral on this post, with special spider fixators and one-way bolts. Posts are provided with a plastic cap.



Rectangular post system

80 x 60 x 2,5 mm or 120 x 60 x 3.0 mm (depending on the height of the fence). The posts have a single row of M8 threaded inserts. The panels are fixed using specific fixing pieces and one-way bolts.

ASSORTMENT SECURIFOR 3D

Fence height mm	Panel size width x height - mm	Number of curves per panel
2000	2518,6 x 2010,6	2
2400	2518,6 x 2417,0	3
3000	2518,6 x 3001,2	3





Securifor® 4D

Panels

The Securifor 4D system's unique feature of front and back alternating wires offers excellent rigidity for high security environments.

Product detail



BENEFITS

High rigidity

Securifor 4D is the ultimate in heavy weldmesh panel fencing when the highest degree of security is needed. With individual alternating wires (1/1) the panel is 10 times stronger than a flat panel.

Adequate delay time

Securifor 4D's unique feature of alternating wires makes it cumbersome to cut when a breach is attempted. The small mesh apertures (standard: 12,7 x 76,2mm) offer no toe- or finger holds, making it near impossible to climb. This results in a longer delay time between first attempt and possible breach, offering response teams and reaction mechanisms adequate time to deploy and intercept effectively.

Visibility

Securifor 4D offers excellent visibility through the fence, essential for use with CCTV and surveillance systems.

Discreet

Securifor 4D has a minimal visual impact on the environment due to its sleek & clean design. Our many color options can be incorporated into an overall look and feel, if required.

Security level



Applications



Functionalities

Post and fixing systems

Securifor 4D can be installed with three different post types:



Rectangular post system

80 x 60 x 2,5 mm or 120 x 60 x 3,0 mm (depending on the post length). The posts have a single row of M8 threaded inserts. The panels are fixed using specific fixators or full length cover plates and one-way bolts.



Bekafix Ultra post system

Lateral fixing of the panels with special metal security clips with bolts. Welded tubular posts (70 x 54 mm) in H-shape with punched holes for positioning/fixing of the panels. Panels are fixed lateral on this post, with special spider fixators and one way bolts. Posts are provided with a plastic cap.



Bekasecure post system

The Bekasecure post's design and high yield strength steel provide the ultimate in high security, rigidity and ease of installation. Posts are delivered with a double range of wholes 10 x 20 mm and the panel is secured with a continuous cover plate and specific stainless steel security bolts. The open profile of the post allows for electrical or fibre optic cabling and is closed with specific metal cap.

Profile : 140 x 135 x 4 mm

Panel Securifor 4D

Mesh pattern (H x W):

Securifor 4D has a standard mesh of 12,7 x 76,2 mm and standard wire diameters of 4mm.



Coating technique

Panels made out of galvanised wires. An adhesion coating is given for perfect adhesion with the polyester coating (min. 100 micron).

Colors

Green RAL 6005.

Other colors are available on request.

Technical drawing

Securifor 4D-1/1

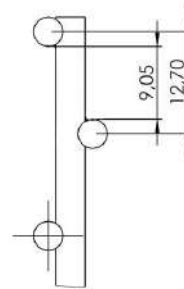

ASSORTMENT SECURIFOR 4D*

Fence height mm	Panel size width x height - mm
2000*	2823,0 x 1985,2
2400*	2823,0 x 2442,4
3000*	2518,6 x 3052,0

* complete assortment is MTO. Other heights on request



Panels

Panels are available in different specifications in a full range of heights from 1000 mm to 2400 mm. All panels are constructed from rolled hollow section horizontal rails with both round and square vertical tube infill. Different railing styles are available to suit different requirements, both visual and security performance. Bow top options are ideal for applications where safety is of paramount importance; for example, the enclosure of children's play areas. Where security and deterrence are required, circular or diamond section straight pales with angle-cut tops to deter climbing are available.



Barofof Round

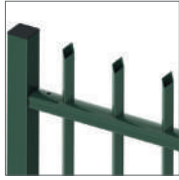

Barofof Square



Barofof Deco

Posts

Posts are made from 60 x 60 x 2 mm section steel tube. The tops are finished with plastic caps.

Gates

A specific range of single and double swing gates is available for each type of Barofof railing system.

Colors

Green RAL 6005.
White RAL 9010.
Black RAL 9005.
Other colors or hot dip galvanised execution are available on request.

Unique fixing system

Black polyamide spacers are inserted into each end of the horizontal rails and are connected to the post with a pin. Solutions for intermediate, end- and corner posts are available.

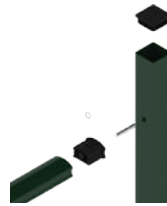

Connection at end post.



Connection to install in obtuse angles above 140°.

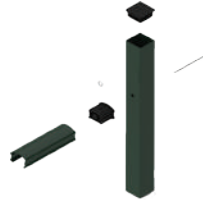

Connection at intermediate post.

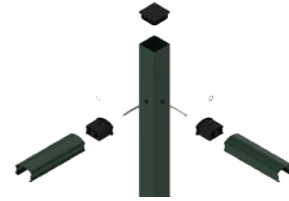

Connection for 90° corners.

Coating technique

Panels are constructed from rolled hollow sections that are hot dipped galvanised after fabrication and polyester coated. Posts are polyester coated on galvanised steel. Barofof railings are available in galvanised execution.



ASSORTMENT BAROFOF

Fence height mm	Panel size width x height - mm	Tube size mm	Post length mm
Assortment Barofof Square			
1500	2520 x 1500	25 x 25 x 1,50	2100
1800	2520 x 1800	25 x 25 x 1,50	2400
2000	2520 x 2000	25 x 25 x 1,50	2600
2400	2520 x 2400	25 x 25 x 1,50	3200
Assortment Barofof Round			
1500	2520 x 1500	25,40 x 1,50	2100
1800	2520 x 1800	25,40 x 1,50	2400
2000	2520 x 2000	25,40 x 1,50	2600
2400	2520 x 2400	25,40 x 2,00	3200
Assortment Barofof Deco			
1000	2520 x 1000	19 x 1,50	1500
1200	2520 x 1200	19 x 1,50	1700
1500	2520 x 1500	19 x 1,50	2100





Pantanet® Family

Welded mesh

The Pantanet Family is a total system, composed of welded galvanised and plastic coated fence on rolls and adapted posts.

Product detail

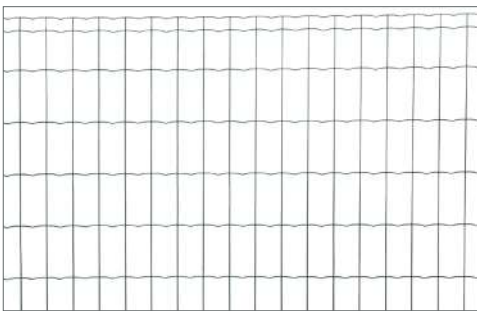

BENEFITS

Aesthetic and discreet

This discreet fence is available in green. The Pantanet Family range is available in metallic anthracite, which makes it unique.

High longevity

The wire is galvanised, resistance welded and plastic coated with maximum adhesion. The metal posts are galvanised inside and outside, passivated and plastic coated, and supplied complete with top caps.

Quick and professional installation

Bekaclip posts with strips guarantee a quick professional installation with an optimal tensioned mesh. A minimum of equipment is needed.

Complete system

Pantanet Family is a complete system with a wide range of roll heights, posts and a wide assortment of swing and sliding gates.

Security level



Applications



Functionalities



Mesh

Welded mesh, manufactured from galvanised wire, resistance welded and then plastic coated. The horizontal wires show a crimp at every mesh. At 25,4 mm from the top, the mesh is reinforced with a second selvedge wire. Pantanet Family also has a second selvedge wire at 25,4 mm from the bottom.

Coating technique

The rolls are made out of galvanised wires. A pre-treatment process guarantees a perfect PVC coating adhesion to the product surface.



Gates

The Pantanet Family system can be completed with the Fortinet and Robusta swing and sliding gates.

Colors

Fence: green BF 6073 or metallic anthracite (BF7016M)

Posts: green RAL 6005 or metallic anthracite (BF7016M)

Installation

Bekaclip posts (for green and anthracite)

The straining and intermediate posts have a mesh fixing strip and are supplied with plastic top caps. The fixing clips are of stainless steel. (*Bekaclip posts in anthracite for do-it-yourself-installation are available with anthracite polyamide clips.*)

Round Steel Posts

In and outside galvanised with a min. layer thickness of 275 g/m² (2 sides combined) following Euro standard EN 10346. Galvanised and plastic coated with polyester with a min. layer thickness of 60 micron.

Mesh dimensions mm	Diameter wire		Tensile strength of the wire	
	Horizontal mm	Vertical mm	Horizontal	Vertical
101,60 x 50,80	2,5	2,5	min. 400 N/mm ²	min. 700 N/mm ²

METAL ROUND & BEKACLIP POSTS

Total height* mm	Fence mm	Straining posts Bekaclip			Round brace posts			Intermediate posts Bekaclip		
		Length mm	Ø mm	Thickness steel plate mm	Length mm	Ø mm	Thickness steel plate mm	Length mm	Ø mm	Thickness steel plate mm
610	610	1100	48	1,2	1500	38	1,25	1100	48	1,2
810	810	1300	48	1,2	1500	38	1,25	1500	48	1,2
1020	1020	1500	48	1,2	1500	38	1,25	1500	48	1,2
1220	1220	1700	48	1,2	1750	38	1,25	1700	48	1,2
1520	1520	2000	48	1,2	2200	38	1,5	2000	48	1,2
1830	1830	2500	60	2	2500	38	1,5	2300	48	1,5
2030	2030	2700	60	2	2700	38	1,5	2500	48	1,5

Length of rolls: 25 m - for some types also 10 m
* All heights available in metallic anthracite





Pantanet® Essential & Light

Welded mesh

The Pantanet Essential & Light system are welded, galvanised and plastic coated fences on rolls, designed for optimal price-quality ratio.

Product detail

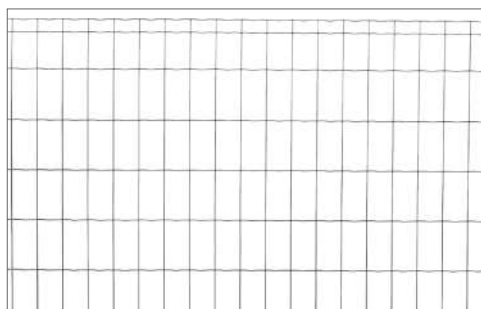

BENEFITS

Aesthetic and discreet

The fence is available in green. The Pantanet Essential range is also available in metallic anthracite.

High longevity

The wire is plastic coated with maximum adhesion. The metal posts are galvanised inside and outside, passivated and plastic coated, and supplied complete with top caps.

Quick and professional installation

Bekacclip posts with strips guarantee a quick professional installation with an optimal tensioned mesh.

Complete system

Pantanet system is a complete system with a wide range of roll heights, posts and a wide assortment of swing gates.

Security level



Applications



Functionalities



Mesh

Welded mesh, plastic coated. The horizontal wires show a crimp at every mesh. At 25,4 mm from the top, the mesh is reinforced with a second selvedge wire (only Pantanet Essential).

Coating technique

The rolls are PVC coated.



Gates

The Pantanet system can be completed with the Fortinet and Robusta swing gates and the Robusta sliding gates.

Colors

Fence: green BF 6073 or metallic anthracite* (BF7016M)

Posts: green RAL 6005 or metallic anthracite** (BF7016M)

Installation

Bekaclip posts (for green and anthracite)

Round steel posts. The straining and intermediate posts have a mesh fixing strip and are supplied with plastic top caps. The fixing clips are of stainless steel. (*Bekaclip posts in anthracite for do-it-yourself-installation are available with anthracite polyamide clips.*)

Round Steel Posts

In and outside galvanised with a min. layer thickness of 275 g/m² (2 sides combined) following Euro standard EN 10346. Galvanised and plastic coated with polyester with a min. layer thickness of 60 micron.

MESH DIMENSIONS OF PANTANET ESSENTIAL & LIGHT

Type	Mesh dimensions mm	Diameter wire		Tensile strength of the wire	
		Horizontal mm	Vertical mm	Horizontal	Vertical
Pantanet Essential	101,60 x 50,80	2,1	2,2	min. 400 N/mm ²	min. 700 N/mm ²
Pantanet Light	101,60 x 76,20	2,1	2,1	min. 400 N/mm ²	min. 700 N/mm ²

* Pantanet Essential is also available in anthracite, for some heights.

METAL ROUND & BEKACLIP POSTS

Total height mm		Fence mm		Straining posts Bekaclip			Round brace posts			Intermediate posts Bekaclip		
				Length mm	Ø mm	Thickness steel plate mm	Length mm	Ø mm	Thickness steel plate mm	Length mm	Ø mm	Thickness steel plate mm
Essential	Light	Essential	Light									
610	600	610	600	1100	48	1,2	1500	38	1,25	1100	48	1,2
810	800	810	800	1100	48	1,2	1500	38	1,25	1100	48	1,2
1020*	1000	1020*	1000	1500	48	1,2	1500	38	1,25	1500	48	1,2
1220*	1200	1220*	1200	1700	48	1,2	1750	38	1,25	1700	48	1,2
1520*	1500	1520*	1500	2000	48	1,2	2200	38	1,5	2000	48	1,2
1830	-	1830	-	2500	60	2	2700	38	1,5	2300	48	1,5
2030	-	2030	-	2700	60	2	2700	38	1,5	2500	48	1,5

Length of rolls: 25 m - for some types also 10 m * Also available in grey anthracite BF7016M





Fortinet® Protect

Welded mesh

The Fortinet Protect is composed of a plastic coated fence on rolls and Bekaclip posts ideal for demarcation of miscellaneous sites.

Product detail

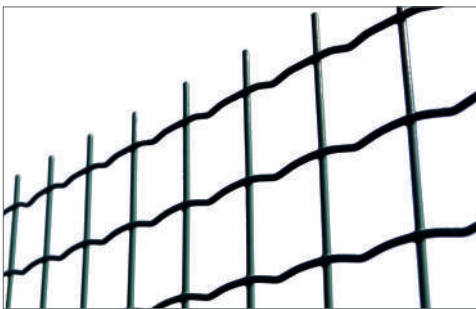

BENEFITS

Rigidity

A rigid fence, constructed from welded wire mesh.

High longevity

The wire is galvanised, resistance welded at every intersection and plastic coated with maximum adhesion. Bekaclip posts are galvanised inside and out, passivated and plastic coated, supplied complete with plastic top cap.

Quick and professional installation

The Bekaclip posts with fixation strip guarantee a fast professional installation with an optimal strained fence. A minimum of accessories is required.

Complete system

Fortinet Protect is a complete system with a range of fence heights, Bekaclip posts and a large variety of swing and sliding gates.

Security level

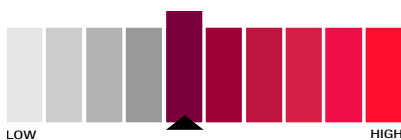

Applications



Functionalities

Mesh

Welded mesh (50,8 x 50,8 mm), from galvanised wire, electrically welded at every intersection and then plastic coated. The horizontal wires have a crimp at every mesh. The wire mesh of 150 cm and higher has barbs of 25,4 mm at one side, to be placed at the top or the bottom. Length of rolls: 25 m

Coating technique

The rolls are made out of galvanised wires. A pre-treatment process guarantees a perfect PVC coating adhesion to the product surface.



Gates

The Fortinet system can be completed with the Fortinet and Robusta swing as well as our large sliding gates range.

Colors

Fence: green BF 6073

Posts: green RAL 6005

Posts



Bekaclip posts

Welded tubular posts with mesh fixing strip. In and outside galvanised with a min. layer thickness of 275 g/m² (2 sides combined) following Euro standard EN 10346. Galvanised and plastic coated with polyester with a min. layer thickness of 60 micron. Fixing clips in stainless steel.

FORTINET PROTECT SPECIFICATIONS

Mesh dimension mm	Wire diameter		Tensile strength of wire	
	Horizontal mm	Vertical mm	Horizontal	Vertical
50,8 x 50,8	2,50	3,00	min. 400 N/mm ²	min. 650 N/mm ²

FORTINET PROTECT ASSORTMENT

Total height* mm	Fence mm	Straining posts Bekaclip			Round brace posts			Intermediate posts Bekaclip		
		Length mm	Ø mm	Thickness steel plate mm	Length mm	Ø mm	Thickness steel plate mm	Length mm	Ø mm	Thickness steel plate mm
1020	1020	1500	48	1,2	1500	38	1,25	1500	48	1,2
1220	1220	1700	48	1,2	1750	38	1,25	1700	48	1,2
1500	1500	2000	48	1,2	2200	38	1,5	2000	48	1,2
1800	1800	2500	60	2	2500	38	1,5	2300	48	1,5
2010	2010	2700	60	2	2700	38	1,5	2500	48	1,5
2510	2510	3500	60	2	3000	38	1,5	3000	48	1,5





Rempart®

Welded mesh

Welded fence with progressive mesh.

Product detail

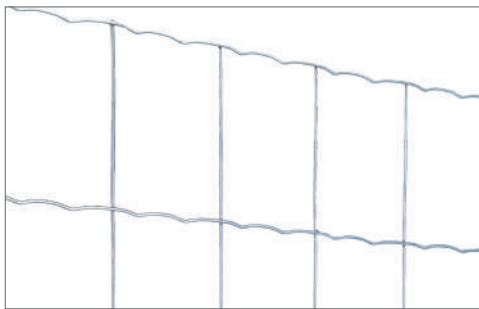

BENEFITS

Strong and rigid

Heavy wire diameters, welded at every intersection. Fence height up to 2,5 m.

Long lifetime

The Zincalu coating ensures a high longevity of the fence. Very good price/quality ratio. Degressive mesh repartition possible.

Long distance

Optimal solution for long distance fences.
Fast and easy installation in combination with Bekaclip post system.

Security level

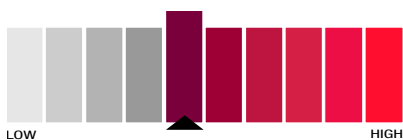

Applications



Functionalities



Mesh

Welded fence with progressive mesh.

Length of rolls: 50 meters

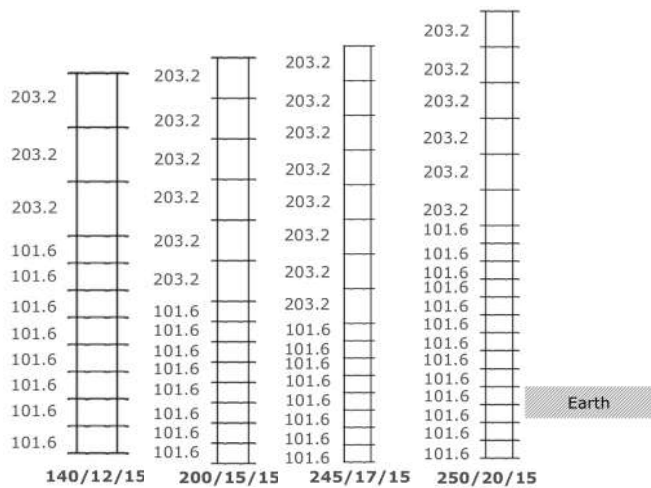

Coating technique

ZINCALU: alloy of Zinc and Aluminium (95% of Zinc + 5% of Aluminium)

PVC coated: green BF 6073 (on request)

Wire

- Selvedge wire: Ø 3,40 mm
- Horizontal and vertical wires: Ø 3,00 mm
- Double crimp in the horizontal wire in every mesh

Posts

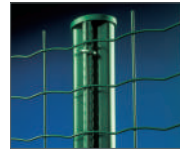

Bekacclip posts

Welded tubular posts with mesh fixing strip. In and outside galvanised with a min. layer thickness of 275 g/m² (2 sides combined) following Euro standard EN 10346. Galvanised and plastic coated

with polyester with a min. layer thickness of 60 micron. Fixing clips in stainless steel.

HEAVY REMPART

Roll height cm	N° of horizontal wires	Distance between vertical wires cm	Types
140	12	15	140/12/15
200	15	15	200/15/15
245	17	15	245/17/15
250	20	15	250/20/15
OPTION: PVC coated (selvedge 3,50 mm/other 3,00 mm)			
140	12	15	140/12/15
200	15	15	200/15/15

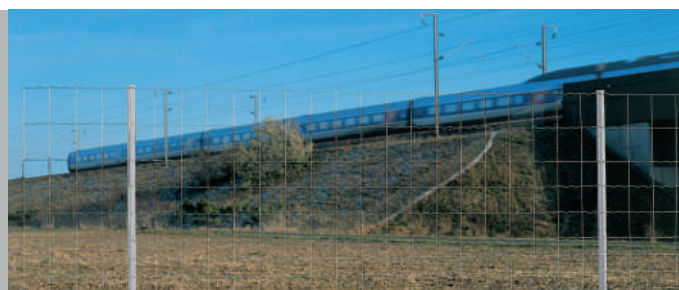



Ursus®
Ursus® Heavy
Ursus® Heavy AS

Knotted mesh

Ursus, the ideal solution for fencing meadows, farming and breeding grounds.

Product detail

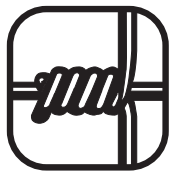

BENEFITS

Ursus

Thanks to the specially developed Zincalu® coating, the life span of the wire extends by at least 50%, in comparison to heavily galvanised coating. The Ursus fence is very easy to install, and the size range suites a wide range of applications.

Ursus Heavy

The Zincalu Super coating ensures a high longevity of the fence. Very good price/quality ratio. Degressive mesh repartition on specific types. Very strong ringlock knot.

Ursus Heavy AS

This fence offers the same benefits as Ursus Heavy, but is combined with high tensile horizontal wires to give increased strength with lower wire diameters. This reduces the roll weight and increases the distance between the intermediate posts, resulting in a faster and cheaper installation.

Security level

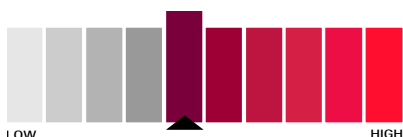

Applications



Functionalities





Coating: Zincalu

Wire diameter and tensile strength:
 line wire: Ø 1,80 mm - 700/900 N/mm²
 stay wire: Ø 1,85 mm - 400/550 N/mm²
 selvedge wire: Ø 2,45 mm - 650/850 N/mm²

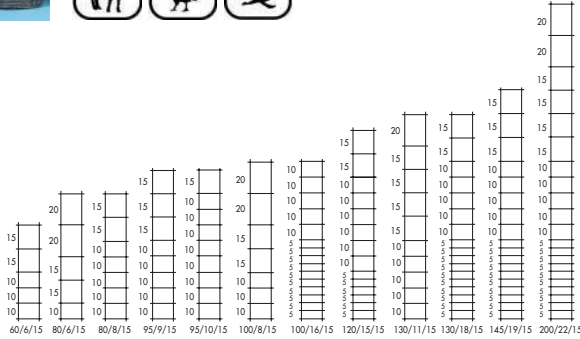

URSUS			
Roll height cm	N° horizontal wires	Distance between vertical wires cm	Type
Rolls of 50 m			
60	6	15	60/6/15
80	8	15	80/8/15
95	9	15	95/9/15
95	10	15	95/10/15
100	8	15	100/8/15
100	16	15	100/16/15
120	15	15	120/15/15
130	11	15	130/11/15
130	18	15	130/18/15
145	19	15	145/19/15
200	22	15	200/22/15

Ursus Heavy

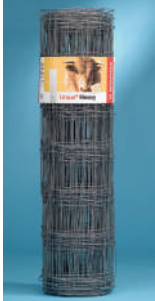

Coating: Zincalu Super

Wire diameter and tensile strength:
 line wire: Ø 3,00 mm - 600/800 N/mm²
 stay wire: Ø 3,00 mm - 600/800 N/mm²
 selvedge wire: Ø 3,70 mm - 550/750 N/mm²
 Ursus knot: Ø 3,00 mm - 400/550 N/mm²



URSUS HEAVY			
Roll height cm	N° horizontal wires	Distance between vertical wires cm	Type
Rolls of 50 m			
80	8	15	80/8/15
100	6	15	100/6/15
100	10	15	100/10/15
120	7	15	120/7/15
120	11	15	120/11/15
140	12	15	140/12/15
Rolls of 75 m			
120	7	15	120/7/15
160	9	15	160/9/15

Ursus Heavy AS

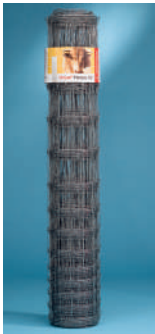

Coating: Zincalu Super

Wire diameter and tensile strength:
 line wire: Ø 2,50 mm - 1150/1350 N/mm²
 stay wire: Ø 2,50 mm - 650/850 N/mm²
 selvedge wire: Ø 3,00 mm - 1050/1250 N/mm²
 Ursus knot: 3,00 mm - 400/550 N/mm²

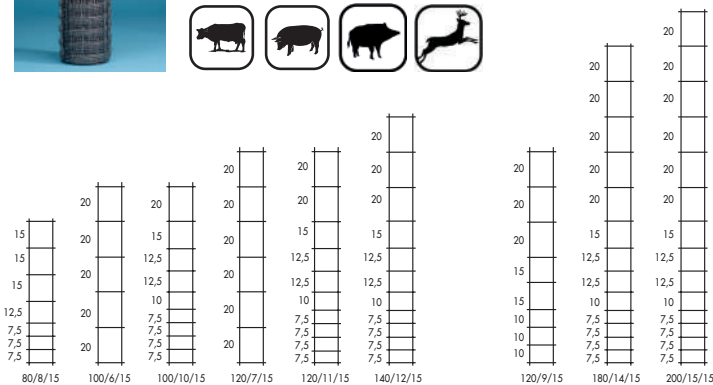

URSUS HEAVY AS			
Roll height cm	N° horizontal wires	Distance between vertical wires cm	Type
Rolls of 75 m			
120	9	15	120/9/15
160	13	15	160/13/15
Rolls of 50 m			
180	14	15	180/14/15
200	15	15	200/15/15
200	15	15	200/15/15

Ursus Heavy

Ursus Heavy AS





Ursus[®] AS

Knotted mesh

Ursus AS are specific fencing products for forestry and highways: Ursus AS Light and AS Medium. They are made with high tensile wires.

Product detail

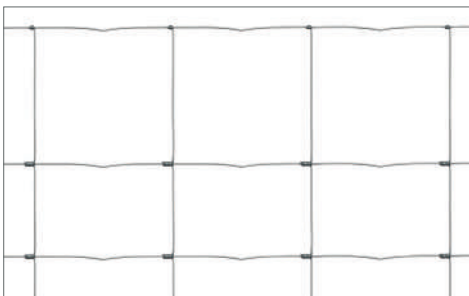

BENEFITS

The Ursus AS range provides a strong (high tensile) professional product. Due to the use of high tensile wires, the fence has an increased resistance to impact and warping. Thanks to these exceptional product qualities, posts only need to be placed every 8 to 10 meters, which makes installing Ursus AS fences 3x faster than other systems!

Ursus AS Light

A low weight but high strength fence. With the smaller mesh apertures at ground level it is effective for small but also bigger animals.

Ursus AS Medium

Heavier wires combined with a Trivalv coating to give maximum performance.

Ursus AS Super

Thicker wires give increased strength. A wide range of sizes to suit all applications.

Security level

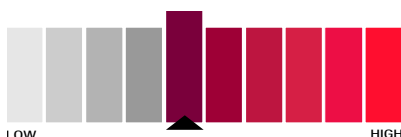

Applications



Functionalities



Ursus AS Light

Coating: Trigalv

line wire: Ø 1,60 mm - 1100/1300 N/mm²

stay wire: Ø 1,60 mm - 400/550 N/mm²

selvedge wire: Ø 2,00 mm - 1200/1400 N/mm²

TRIGALV



Urus AS Medium

Coating: Trigalv

line wire: Ø 2,00 mm - 1200/1400 N/mm²

stay wire: Ø 1,90 mm - 400/550 N/mm²

selvedge wire: Ø 2,50 mm - 1150/1350 N/mm²

TRIGALV



Ursus AS Super

Coating: Trigalv

line wire: Ø 2,50 mm - 1150/1350 N/mm²

stay wire: Ø 2,50 mm - 400/550 N/mm²

selvedge wire: Ø 3,00 mm - 1050/1250 N/mm²

TRIGALV



Mesh dimensions

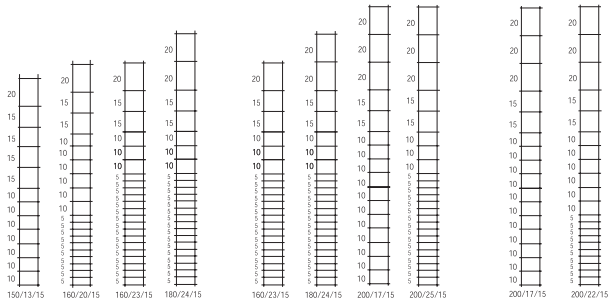

Ursus AS Light

Ursus AS Medium

Ursus AS Super

URSUS AS LIGHT

Roll height cm	N° horizontal wires	Distance between vertical wires cm	Type
Rolls of 50 m			
150	13	15	150/13/15
160	20	15	160/20/15
160	23	15	160/23/15
180	24	15	180/24/15

URSUS AS MEDIUM

Roll height cm	N° horizontal wires	Distance between vertical wires cm	Type
Rolls of 50 m			
160	23	15	160/23/15
180	24	15	180/24/15
200	17	15	200/17/15
200	25	15	200/25/15

URSUS AS SUPER

Roll height cm	N° horizontal wires	Distance between vertical wires cm	Type
Rolls of 50 m			
200	17	15	200/17/15



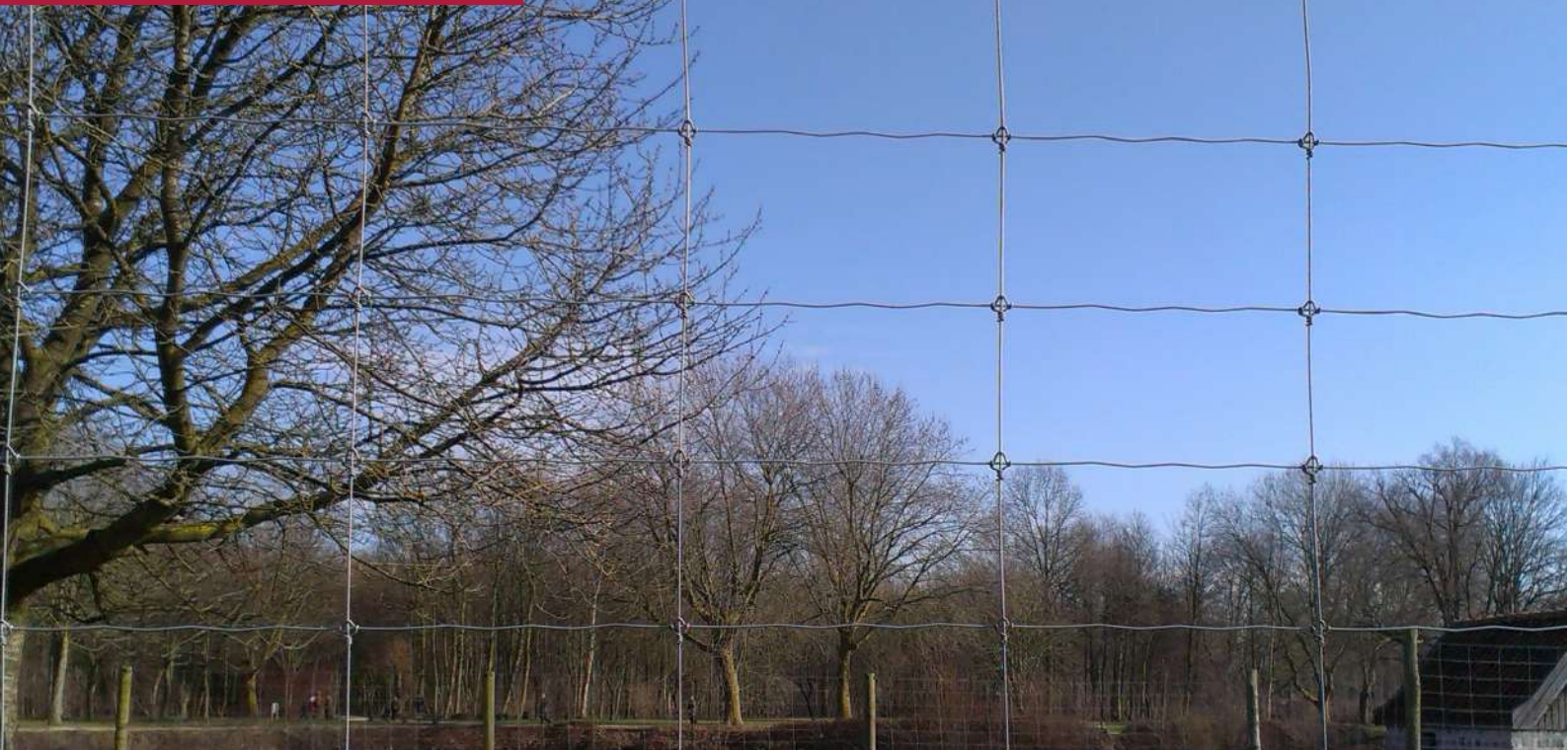

Ursus® Cyclone

Knotted mesh

Knotted mesh made of high tensile wires and a 'unique tight lock knot' for strength and fast installation.

Product detail



BENEFITS

Independent knots

The independent knots increase the structural strength of the fences. They allow the wires to follow the contours. The special knot secures the stay wires to the lines wires.

Quick installation

Due to the high tensile horizontal wires the fence can be easily strained and erected, even on hills and hollows. While needing less posts to install, the total fence cost is much lower than normal wires. (Posts can be spaced up to 10 metres apart)

Rigid

This fence is easy to strain and allows for impact to dissipate over the fence and return to the original condition. No additional line wires are required to support the fence.

Security level

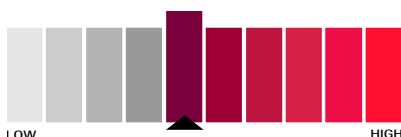

Applications



Functionalities



Wires

Line wires are spaced for different stock types to provide maximum strength and security at the most needed points of contact. They are continuous in length and made from high tensile wire.



The stay wires (vertical) are continuous in length. They combine with the knots and tension curves to create overall rigidity and elasticity. The load of any impact will spread and dissipate over the full fence height and for some distance on either side. The stay wires are standard available at 160 mm or 320 mm spacing for 90 cm height.

Specifications

Wire diameters & tensile strength

Line & selvedge wire: 2.50 mm / high tensile (appr. 1.300 N/mm²)
 Stay wire : 2.50 mm / medium tensile (appr. 800 N/mm²)
 Knot wire : 2.24 mm / standard tensile (appr. 500 N/mm²)

Coating



In-house made Trigalv® wires (heavy galvanized, min 230 g/m²)

Spacing between stay wires	standard 160 & 320 mm (225 & 600 mm are possible on request)
Crimp	deep tension crimp in each mesh
Maximum fence height	2440 mm
Maximum number of line wires	21 wires
Standard roll length	100 m

Available stockrange

Ursus® Cyclone

Roll height cm	Type	Roll length m	Roll weight kg
80	8/800/150	100	67,7
90	8/900/300	100	49,8
120	10/1200/150	100	90,5
155	15/1550/150	100	131,8
190	17/1900/150	100	153,40
205	18/2050/150	100	163,60
224	21/2440/150	100	193,9

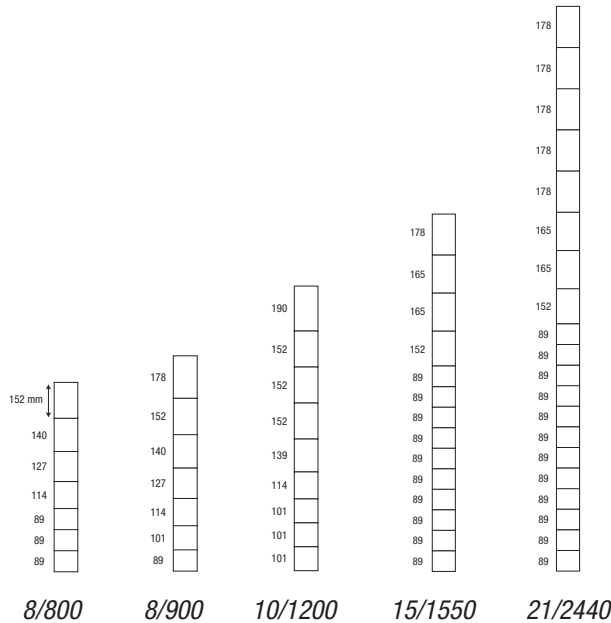



Plasitor®

Woven mesh

The Plasitor fencing system consisting of a woven wire diamond pattern mesh retains its shape and is at the same time elastic.

Product detail



BENEFITS

Retains shape and elasticity

Plasitor has solid core wires by which the shape of the fence is maintained. This results in a flexible installation. The elasticity is provided by the interwoven wires.

Long lifetime

Betafence's coating technology is state of the art and guarantees an extra high longevity. After galvanising the wire is given an extra protection coating of durable PVC.

Support for climbing plants

Plasitor can be installed with a top rail which makes it ideal for climbing vegetation. Appropriate posts sizes are required to support the extra weight.

Security level



Applications



Functionalities



Mesh

Made out of hard steel wire with single torsion. The mesh has a diamond pattern. Edges at top and bottom are folded and hooked onto each other. Type 2,70: one side folded and one side barbed. Length of rolls: 25 m.

Mesh dimension	Core Wire diameter	Finish diameter (with coating)
50 x 50 mm	1,80 mm	2,70 mm
50 x 50 mm	2,00 mm	3,00 mm

Needed Fixation

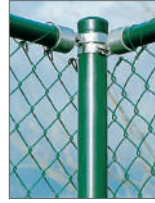

- Line & binding wires
- Wire holder
- Tension collets
- Wire tensioners
- Tension bars
- Top rails
- Bent arms
- Coated barbed wires

Gates

The Plasitor system can be completed with the Fortinet, Egidia and Robusta gates.

Coating technique



The steel wires are galvanised and then plastic coated. The posts are galvanised inside & out (min. coating 275 g/m², both sides together), in accordance with Euro standard EN 10346. Afterwards an adhesion coating is applied and finally the posts are plastic coated (min. 60 micron).

Colors

Fence: green BF 6073 and black BF 3090

Posts: green RAL 6005, some types black RAL 9005

Post

Welded tubular round posts

Tensile strength of the steel: 340 à 510 N/mm², according to EN 10325-2.

The tension- and intermediate posts are equipped with a hole to position your wire holder at 40 mm from the top of the post.

The wire holder (to be ordered separately) is made out of a polyamide reinforced with glass fiber and supplied with a stainless steel staple.

The posts are completed with a plastic cap.

For vegetation the distance between the posts and the diameter of the posts has to be adapted to carry the additional weight.

ASSORTMENT PLASITOR SYSTEM

Total height fence			Dimensions posts								
Assembled Height			Round straining posts			Round brace posts			Round intermediate posts		
Total height mm	Roll height mm	Barbed wire mm	Length mm	Ø mm	Thickness steel mm	Length mm	Ø mm	Thickness steel mm	Length mm	Ø mm	Thickness steel mm
1000	1000	-	1500	38	1,25	1500	38	1,25	1500	38	1,25
1250	1250	-	1750	48	1,25	1750	38	1,25	1750	38	1,25
1500	1500	-	2200	60	2	2200	38	1,5	2100	48	1,25
1800	1800	-	2500	60	2	2500	38	1,5	2400	48	1,5
2000	2000	-	2700	60	2	2700	38	1,5	2600	48	1,5
With top rail											
1500	1500	-	2200	60	2	-	-	-	2100	48	1,25
1800	1800	-	2500	60	2	-	-	-	2400	48	1,5
2000	2000	-	2700	60	2	-	-	-	2600	48	1,5
With one row of barbed wire											
1600	1500	100	2200	60	2	2200	38	1,5	2100	48	1,25
1900	1800	100	2500	60	2	2700	38	1,5	2400	48	1,5
2100	2000	100	2700	60	2	2700	38	1,5	2600	48	1,5
With bent arm											
2300	2000	300	3250*	60	2	3000	38	1,5	3100*	48	1,5

(*) posts with drillings for wire holders every 495 mm.





Collfort®

Privacy solutions

Modular and effective solutions to create privacy on a new or installed Betafence fence system.

Product detail



BENEFITS

Decorative

Decorative & stylish privacy solutions in wood.

Compatibility

Betafence's privacy products Collfort offers privacy solutions for different types of welded panel such as Bekafor or Nylofor 3D range.

Easy installation

This privacy systems can be easily installed on an existing or newly installed fence. For installation, a very limited number of tools is required.

Guarantee

The privacy solutions are guaranteed for a period of 10 years (for the guarantee conditions: see the product labels).

Security level



Applications



Functionalities



Bekafor Collfort

Privacy slats in treated, Nordic pine. Compatible with Bekafor Classic panels (width 2000mm).

One kit includes :

- 43 vertical slats
- horizontal, trapezoidal slats (following the number of folds in the panel)

Nylofor Collfort

Privacy slats in treated, Nordic pine. Compatible with Nylofor range (width 2500 mm) : Nylofor 3D, Nylofor 3D Pro.

One kit includes :

- 53 vertical slats
- horizontal, trapezoidal slats (following the number of folds in the panel)

Collfort assembly

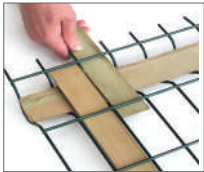

Step 1

Insert the horizontal slats in the folds (depending on the fold type, the horizontal cross beam is put in the other sense).

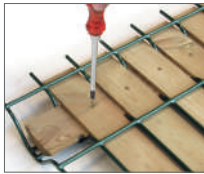

Step 2

Screw or staple the vertical slats onto the horizontal slats in the fold (screws or staples are not supplied). One fixing point on the horizontal slat per vertical slat should suffice.



Step 3

Fix your panel to your post.



Step 4

Insert the outer slats, then attach them. Repeat this procedure for each privacy panel. Your installation is finished.

COLLFORT ASSORTMENT

Type	Material	Panel Height in mm	Panel Width in mm	Compatible with
Bekafor Collfort	Treated Nordic pine Natural color	1730	2000	Bekafor Classic panels
		2030		
Nylofor Collfort	Treated Nordic pine Natural color	1530	2500	Nylofor 3D panels Nylofor 3D Pro panels
		1730		
		1930		





Screeno® Line

Privacy solutions

Modular and effective solution to create privacy on a new or installed Betafence panel fences.

Product detail



BENEFITS

Decorative

Decorative & stylish privacy solution, available in a wide range of different colors and heights.

Compatibility

Betafence's Screeno Line can be combined with Bekafor Classic residential panels and with Nylofor 3D and 3D Pro professional panels.

Easy installation

All privacy systems can be easily installed on an existing or newly installed fence. For installation, no tools are required.

Guarantee

The strong privacy profiles are guaranteed for a period of 10 years (for the guarantee conditions: see the product label).

Applications



Functionalities



Bekafor Screeno Line

Privacy slats in PVC, standard available in 3 colors:

- green
- anthracite
- imitation light woodlook

Compatible with 2m wide panels:

- Bekafor Classic

Nylofor Screeno Line

Privacy slats in PVC, standard available in 4 colors:

- green
- anthracite
- imitation light woodlook
- imitation dark woodlook

Compatible with 2,5 meter wide panels:

- Nylofor 3D
- Nylofor 3D Pro.

Installation

The horizontal & vertical slats can easily be glided in the panel. The vertical slats can be fixed to the panel's bottom horizontal wire, by means of clips (included in the packing) and without tools.

The specific shape of the horizontal beam can be installed in 2 directions, which enables installation with the different panel types. A top profile guarantees perfect finishing.

Material

- Privacy slats in PVC

Compatible panel heights

- For Bekafor panels : 103 / 123 / 153 / 173 / 203 cm
- For Nylofor panels : 103 / 123 / 153 / 173 / 193 / 203 / 243 cm

Packaging

Each set contains all elements to create privacy on a complete panel:

- slats to be inserted vertically (including 2 smaller slats to be used at the panels' extremities)
- trapezoidal slats, to be inserted in the panels' horizontal 3D-noses
- clips for fixation of the vertical slats on the panels' bottom horizontal wire
- a top profile, for perfect finishing

Remark

When equipping a fence with a privacy infill, specific attention needs to be given to the post type and installation (for security reasons).

Contact us for more information.





Screeno® Wave

Privacy solutions

Easy to install and effective solution to create privacy on a new or installed Nylofor® 2D, or 2D Super panel.

Product detail

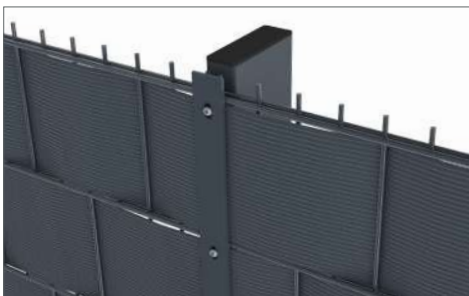

BENEFITS

Fast & effective

Screeno Wave offers immediate & effective 100% privacy.

Easy installation

Screeno Wave can be easily woven through the meshes of on an existing or newly installed fence, thanks to the flexible & cut-to-length strips. For installation, no tools are required.

Compatibility

The Screeno Wave strips can be used with panels type Nylofor® 2D & Nylofor® 2D Super. The different colors allow to match the color of the fence.

Quality

The Screeno Wave strips are made of high quality Polypropylene. They are extremely strong and durable. Moreover, the strips are fully recyclable.

Applications



Functionalities



Be creative

Screeno® Wave can be installed in different ways.
Use your imagination to create your own decorative privacy solution.
Here we give you some ideas how to wave the strip into your fence.



Technical information

- Polypropylene
- 3 standard colors available:
green RAL 6005 / grey RAL 7016 / stone grey RAL 7030
- Strip thickness: 1.00 mm
- Strip width: 190 mm
- Strips are cut-to-length: 2530 mm
- 10 strips per pack
(1 pack offers privacy for a complete panel of 2500 x 2030 mm)

Posts



O-LOX SUPER post:

- Rectangular post with cross section 120 x 40 mm
- Plate thickness 2.00 mm
- With pre-assembled polyamide clamps
and steel flat cover plate 40 x 4 mm
- Posts are covered with a plastic cap

Posts are available on MTO basis:

- for installation in concrete, or with welded floor plate.
- in hot dip galvanized or polyester coated execution.

ASSORTMENT SCREENO® WAVE

Material	Color*	Packaging	Compatibility
Polypropylene	Green RAL 6005	Pack of 10 strips	Nylofor® 2D
	Grey RAL 7016	Strip length 253 cm	Nylofor® 2D Super
	Stone grey RAL 7030	1 pack = privacy for one complete panel 250x203 cm (width x height)	Nylofor® F

*Other colors & strip lengths are available on request

When equipping a fence with a privacy infill, specific attention needs to be given to the post type & installation (security reasons). Contact us for more information.

Panel height in mm	Post length in mm (installation in concrete)	Post length in mm (with welded floorplate)	O-Lox Super Post profile in mm
1830	2400	1884	120/40/2
2030	2700	2084	120/40/2





Gabion Stonewall

Panels

Gabion Stonewall is a complete system with a unique concept of posts to build filled walls.

Product detail



BENEFITS

Unique & flexible

Gabion Stonewall has a new, unique post concept to build filled walls. Flexibility in height and width of the wall. Additionally this product is easy to install.

Design

Specific design as the posts and accessories are invisible.

Noise reduction

The gabion stone wall has been tested in an accredited laboratory, according to ISO 10140-2 (30 cm wide wall filled with lava stones). The gabion stone wall reduces the sound passing through the wall by 9 decibel (dB).

Security level



Applications



Functionalities



Panel

These are welded panels 2000 mm width. They are available in several heights.

Mesh sizes: 50 x 50 mm.

Wire diameter: 4 mm.

The system is completed with cover panels available in 3 widths of 200 mm, 250 mm and 300 mm depending of the thickness of your Gabion Stonewall.

Posts and fixing

A new post concept has been developed for the Gabion Stonewall and posts are invisible, once the filled wall is finished. The square posts have a section of 60 x 60 mm.

The panels are fixed on the post with one universal fastening part. The pattern of holes in the fastening parts makes it possible to build a filled wall of 200 mm, 250 mm or 300 mm thick.

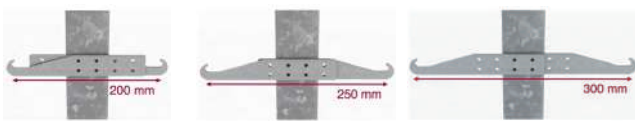

200 mm

250 mm

300 mm

Coating

ZINCALU

The panels are Zincalu® coated. Due to a specially designed Zincalu covering, the lifetime is increased by 50% compared with heavy galvanising. The posts are hot galvanised.

Accessories need



Fastenings

Universal fastening part, hot galvanised, to fix the welded panel to the post.



Spacers

Zincalu coated spacers at the panel weld seams so that they cannot shift. The length depends on the thickness of the wall (200/250/300 mm).



Self-drilling screws

To fix the fastening parts to the post. To be provided by the customer.



Stainless steel clips

The (Fortinet) clips are used to fix the cover panels to the panels.

GABION STONEWALL PANEL RANGE

Panel dimensions L x H in mm	Color	Length of posts in mm	Number of fastenings per post	Number of spacers per running metre
2000 x 1600	Zincalu	2000	6	18
2000 x 1800	Zincalu	2200	6	21
2000 x 2000	Zincalu	2400	8	24

GABION STONEWALL COVER PANEL RANGE

Height mm	Length mm	Color
200	2000	Zincalu
250	2000	Zincalu
300	2000	Zincalu





HoriZen® Composite system

Privacy solutions

A wide range of WPC board panels for immediate privacy with a natural and decorative look, in different designs and colors.

Product detail

Classic



Classic XL



Platinum and Platinum XL

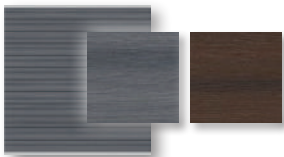

BENEFITS

Composite material: natural look and maintenance free

WPC (Wood Polymer Composite) combines the natural look & warm feel of wood with the low maintenance & rigidity of plastic. The weather resistant product does not require painting or varnishing. WPC is extremely durable, will not rot nor splinter and is a perfect alternative for tropical hard wood.

Large range

The composite boards come in 3 different designs with attractive & fashionable colors. A range of single & double swing gates with Composite infill is available as well.

Easy installation

- The composite boards with tooth/groove principle are installed with the HoriZen Basic post.
- The fence height can be adapted by putting less boards on top of each other, the boards can easily be cut to adapt de width of the panel.
- HoriZen Clamp posts are used in combination with Glass or Laminate panels.

Endless personalization

- combining different colors in one fence
- mounting the boards vertically (adaptor profile)
- combining composite boards with the HoriZen glass or Laminate panels
- integrating the HoriZen decorative boards or by adding a LED light bar.

Applications



Functionalities



HoriZen composite boards assortment

HoriZen composite Classic

- Extruded WPC boards, with tooth-groove principle
- Available in 4 colors : sand, almond, anthracite & grey
- Board height : 150 mm, board length : 1780 mm
- One side of the boards is plain, the other side has a horizontal groove.
- 1 pack contains 12 boards (= fence panel 1800 x 1800 mm) & the aluminum top & bottom profiles (in silver or anthracite)

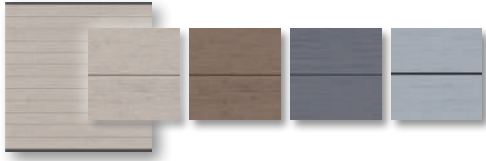

HoriZen composite Classic XL

- Extruded WPC boards, with tooth-groove principle
- Available in 2 colors : anthracite & grey
- Board height : 300 mm, board length : 1780 mm
- Both sides of the boards are plain.
- 1 pack contains 6 boards (= fence panel 1800 x 1800 mm) & the aluminum top & bottom profiles

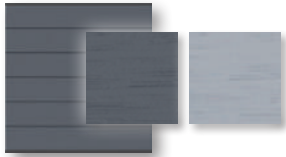

HoriZen composite Platinum

- Co-extruded WPC boards, with tooth-groove principle.
- Available in 2 colors : brown & grey
- Board height : 150 mm, board length : 1780 mm
- Both sides of the boards are plain.
- 1 pack contains 12 boards (= fence panel 1800 x 1800 mm) & the aluminum top & bottom profiles

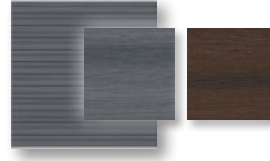

HoriZen composite Platinum XL

- Co-extruded WPC boards, with tooth-groove principle.
- Available in 2 board colors : brown & grey (alu frame in anthracite or silver)
- Board height : 300 mm, board length : 1780 mm
- Both sides of the boards are plain.
- 1 pack contains 6 boards (= fence panel 1800 x 1800 mm) & the aluminum top (for aesthetic finishing) & bottom profile (for rigidity)

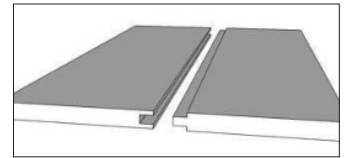
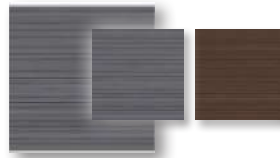

Posts & fixings

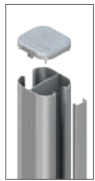

HoriZen Basic post

- The composite board panels are installed with the Basic post. This aluminum extruded post is available in 3 different heights and in 2 different versions:
- posts for installation in straight line
 - corner posts (for installation in corner 75° - 180°)



HoriZen Clamp post

- When the composite board panels are combined with Glass or Laminate panels, the specific Clamp post is used. This aluminum extruded post is available in 2 different lengths and 2 different versions:
- posts for installation in straight line
 - corner posts (for installation in corner 90°)

Technical information

- WPC (Wood Polymer Composite) extruded boards
- HoriZen composite Platinum: A special coating gives a premium look and extra protection against stains from water and dirt.
- Made with PEFC certified wood
- 100% recyclable
- 10 year guarantee (see our quality policy)
- the fence width can be altered easily, by cutting the boards. The fence height can be lowerd by using shorter posts or by cutting the post and less boards
- the Classic, XL & Platinum (XL) boards and the aluminium top & bottom profiles are individually available, in all colors.
- extra long Basic posts of 2980 mm are available for installation on slopes.

ASSORTMENT HORIZEN COMPOSITE BOARDS

Type	Profile colors	Aluminium Top- & Bottom profile available colors	Standard panel dimension (width x height) mm	Panel composition	Compatible posts Tube size mm				
					Fence height mm	Basic post		Clamp post	
						In concrete mm	On baseplate mm	In concrete mm	On baseplate mm
Classic	anthracite grey almond sand	anthracite or silver	1800 x 1800	12 boards of 1780 x 150 mm + Aluminium top- & bottom profile	1800	2400	1925	1925 + elongation piece	1925 + elongation piece
Platinum	grey brown	silver anthracite							
Classic XL	anthracite grey	anthracite silver		6 boards of 1780 x 300 mm + Aluminium top- & bottom profile					
Platinum XL	grey brown	silver anthracite							

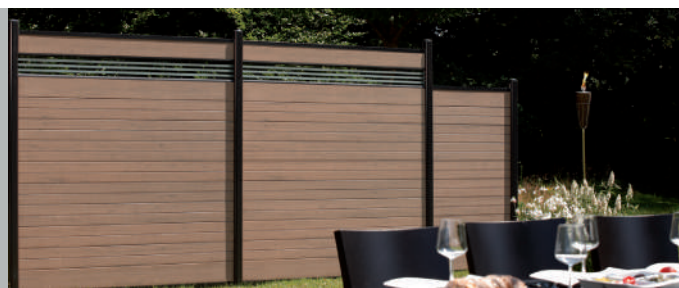



HoriZen[®] Aluminium system

Privacy solutions

Boards in powder-coated Aluminium. The boards are stacked to form privacy panels with a lean and modern design.

Product detail



BENEFITS

Aluminium : design and maintenance free

The Aluminium boards give the privacy fence an attractive design, which is especially pleasing with modern constructions. The Aluminium is weather resistant and does not require any maintenance.

Clever range

The Aluminium boards are 150 mm high, both sides of the board are plain. The boards are available with a silver or anthracite powder coating. Each pack also contains an Aluminium top & bottom profile, for a perfect finishing.

Easy installation

The Aluminium boards with tooth/groove principle are installed with the HoriZen Basic post. The fence height can be adapted by putting less boards on top of each other. To adapt the panel width, the boards can be easily cut to the required length. When combining the Aluminium boards with Glass or Laminate panels, the Clamp post is to be used.

Endless personalization

Customize your fence by combining the 2 colors in one fence, mounting the boards vertically (adaptor profile), combining the boards with the HoriZen Glass or Laminate panels or by integrating the HoriZen decorative boards in Glass, polycarbonate and stainless steel, or by adding a LED light bar.

Applications



Functionalities



HoriZen Aluminium boards assortment

Classic

- Aluminium boards, with tooth-groove principle
- Available in 2 standard polyester coatings : silver & anthracite
- Board height : 150 mm, board length : 1790 mm. Separately, extra long boards of 2380 mm are individually available as well.
- Both sides of the boards are plain.
- 1 pack contains 12 boards (= fence panel 1800 x 1800 mm) & the Aluminium top & bottom profiles



**HoriZen Aluminium
Classic silver**

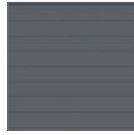

**HoriZen Aluminium
Classic anthracite**

Technical information

- Aluminium profiles
- Polyester coated
- Colors : silver & anthracite
- 100% recyclable
- 10 year guarantee (see our quality policy)
- the fence width can be altered easily, by cutting the boards. The fence height can be lowerd by using shorter posts and less boards.
- the Aluminium boards and the Aluminium top & bottom profiles are individually available, in all colors. Extra long boards of 2380 mm are separately available as well.
- extra long Basic posts of 2980 mm are available for installation on slopes.

Posts & fixings

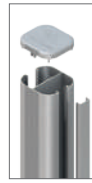

HoriZen Basic post

The Aluminium board panels are installed with the Basic post. This aluminum extruded post is available in 3 different heights and in 2 different versions:

- posts for installation in straight line
- corner posts (for installation in corner 75° - 180°)



HoriZen Clamp post

When the composite board panels are combined with Glass or Laminate panels, the specific Clamp post is used. This aluminum extruded post is available in 2 different lengths and 2 different versions:

- posts for installation in straight line
- corner posts (for installation in corner 90°)

ASSORTMENT TABLE HORIZEN ALUMINIUM BOARDS

Type	Boards available colors	Alu top & bottom profiles available colors	nominal panel size (width x height) mm	panel content	Compatible posts				
					fence height mm	Basic		Clamp	
						in concrete mm	on base plate mm	in concrete mm	on base plate mm
Classic	anthracite	anthracite	1800 x 1800	12 boards of 1790 x 150 mm + alu top & bottom profile	1800	2400	1925	1925 + elongation piece	1925 + base plate
	silver	silver							





Horizen[®] Glass system

Privacy solutions

Made out of safety Glass & available in different designs & dimensions.
Creates privacy & serves as a windscreen along the house and the terrace.

Product detail



BENEFITS

Safety Glass

The Glass panels are made out of safety Glass (conform EN 12150 norm) and have a high resistance to bending and shocks.

Large range

The Glass panels are available in 4 different finishings : transparent, mat or with a mat/transparent pattern. Each of the 4 finishings comes in different panel sizes.

Endless personalization

Customize your fence by:

- Combining the different panel finishings & sizes
- Combining the Glass panels with the Composite or Aluminum boards or the Laminate panels.

Applications



Functionalities



Horizon Glass panel assortment



Clear

- Fully transparent Glass panel
- Available in 4 standard sizes:
 - 900 x 900 mm
 - 900 x 1800/900 mm, slanted
 - 1200 x 1800 mm
 - 900 x 1800 mm



Mat

- Completely mat Glass panel
- Available in 5 standard sizes:
 - 900 x 900 mm
 - 900 x 1800/900 mm, right slanted
 - 900 x 1800/900 mm, left slanted
 - 1200 x 1800 mm
 - 900 x 1800 mm



Alpha

- Mat Glass panel, with 2 or 4 transparent stripes
- Available in 5 standard sizes:
 - 900 x 900 mm
 - 900 x 1800/900 mm, right slanted
 - 900 x 1800/900 mm, left slanted
 - 1200 x 1800 mm
 - 900 x 1800 mm



Beta

- Mat Glass, gradually becoming transparent towards top of the panel
- Available in 5 standard sizes:
 - 900 x 900 mm
 - 900 x 1800/900 mm, right slanted
 - 900 x 1800/900 mm, left slanted
 - 1200 x 1800 mm
 - 900 x 1800 mm

Posts and fixings



HorizZen Clamp post

- For installation of Glass panels, the specific Clamp post is used. This aluminum extruded post is available in 2 different lengths and 2 different versions:
- posts for installation in straight line
 - corner posts (for installation in corner 90°)

Technical information

- Safety Glass
- Conform EN 12150 norm
- Glass thickness : 8 mm
- The Mat, Beta & Alpha panels are polished at one side of the panel, hence the right & left versions of the slanted panels.
- 10 year guarantee (see our quality policy)
- Special Glass panels can be cut to smaller size on request (square & rectangular panels only).
- The shorter post can be used for installation of the 900 x 900 mm panel or slanted panel (the 900 mm high side of the panel)
- Not for use as balustrade on roof terrace.
- Wind anchor compulsory if fully exposed to strong winds.
- 4 rubber seals to fix the panels in the posts are provided with each Glass panel.

ASSORTMENT TABLE HORIZEN GLASS PANELS

available executions	panel size width x height mm	panel height mm	Clamp post	
			in concrete mm	on base plate mm
Clear Mat Alpha Beta	900 x 900 (1) 900 x 1800/900 left slanted (2) 1200 x 1800 (3) 900 x 1800 (4)	900	1050 + elongation piece	1050 + base plate
	900 x 1800/900 right slanted (5)	1800	1925 + elongation piece	1925 + base plate

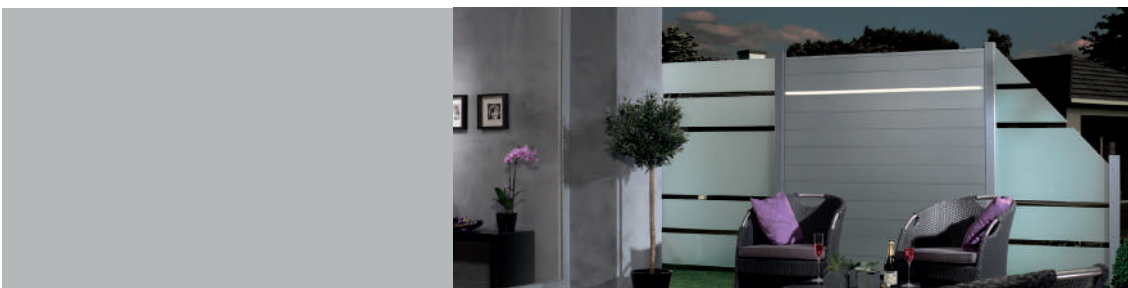
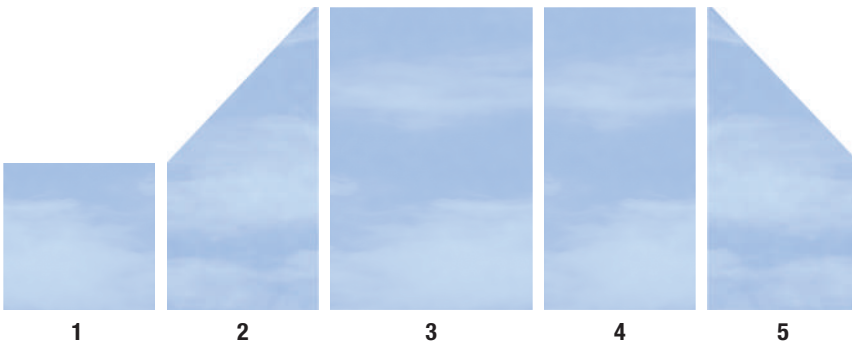



Horizen[®] Laminate system

Privacy solutions

The Laminated panels are available in different colors & dimensions and create privacy in a stylish way.

Product detail



BENEFITS

Laminate : new look & maintenance free

Laminate has proven its resistance for outside applications. It is an extremely durable & stable material and does not require any maintenance. Its surface is smooth, its colors are attractive.

Large range

The Laminate panels are available in 3 different colors : red, titan grey & slate grey. Each of the 3 colors comes in different panel sizes & designs. The rectangular panels are available with decorative slots at the top of the panel.

Endless personalization

Customize your fence by:

- Combining the different panel sizes or colors
- Combining the Laminate panels with the Composite or Aluminium boards or the Glass panels.

Applications



Functionalities



HoriZen Laminate panel assortment

3 colors

- Red
- Titan grey
- Slate grey



red



titan grey



slate grey

4 standard panel sizes:

- 900 x 900 mm
- 900 x 1800/900 mm, slanted
- 1200 x 1800 mm, with or without top design
- 900 x 1800 mm, with or without top design

Technical information

- Laminated panel
- Panel thickness : 6 mm
- 100% recyclable
- 10 year guarantee (see our quality policy)
- the Laminate panels can easily be cut to the required size (appropriate tooling necessary)
- the shorter posts can be used for installation of the 900 x 900 mm panel or slanted panel (the 900 mm high side of the panel)
- 4 rubber seals to fix the panels in the post are provided with each Laminate panel.

Posts & fixings



Clamp post

Laminate panels are always installed with the Clamp post. This Aluminium extruded post is available in 2 post lengths and in 2 different versions:

- post for installation in straight line
- corner post (for installation in corner 90°).

ASSORTMENT TABLE HORIZEN LAMINATE PANELS

available colors	panel size width x height mm	panel height mm	Clamp post	
			in concrete mm	on base plate mm
red titan grey slate grey	900 x 900 (1) 900 x 1800/900 slanted (2) 900 x 1800 (3)	900	1050 + elongation piece	1050 + base plate
	1200 x 1800 (4) 900 x 1800 top design (5) 1200 x 1800 top design (6)	1800	1925 + elongation piece	1925 + base plate

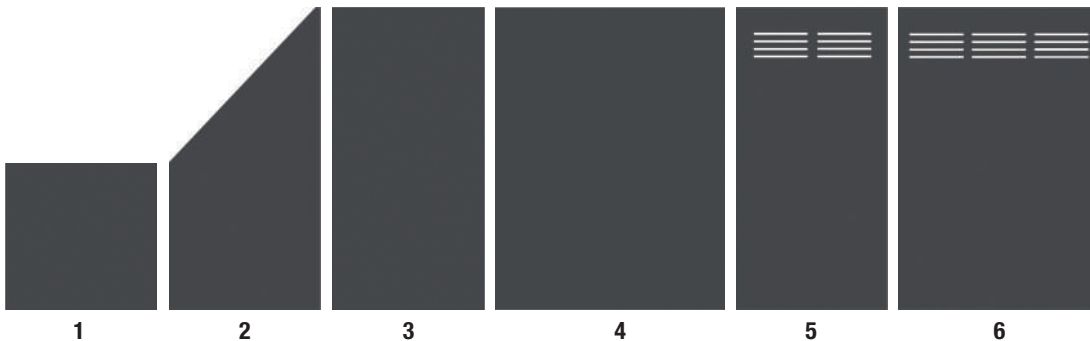

HoriZen system

Decoration boards & LED light

Decoration

Decorative boards and LED strip to personalize the HoriZen privacy screens.

Product detail



Bubble



Gamma



Delta



Theta

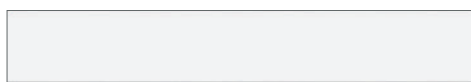

Decor-Mat

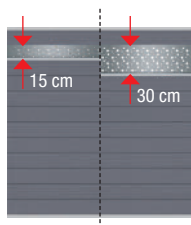

Power supply



LED bar



Extension cable with one exit



Extension cable with two exits

BENEFITS

- All accessories are very easy to install between the horizontal boards
- The boards (except Glass) and LED strips can be cut to size
- The electric cabling for LED strips disappears in the post
- Flexible placing of the decorative elements
- Large assortment

Description

Decorative boards

- 5 attractive decoration profiles :
 - 2 designs in stainless steel (Bubble & Gamma), thickness: 1,5 mm
 - 1 design in Polycarbonate Glass, 5 mm, mat white
 - 2 designs in Safety Glass, 6 mm (Delta & Theta)
- Length: 1790 mm
- Height: 150 and 300 mm
- Inclusive aluminium mounting strip (When a LED strip is integrated in a board panel, the panel height increases by 30 mm. Add an extra aluminum bottom profile in the adjacent)

LED Light bar

- High qualitative extruded plastic profile with integrated white LED strip
 - connection cable included
 - IP 67 waterproof
 - 24 V DC power supply
- Profile of 1780 mm long, 30 x 20 mm, can be cut to the desired length easily

Accessories for LED

- 3 power supplies (for 2, for 3, for 6 ledstrips)
- 6 extension cables (3 x 1 + 3 x 2 exits)

ASSORTMENT TABLE FOR DECORATION BOARDS & LED LIGHT

Product	Type	Material	Available sizes width x height mm	Combinable with	Compatible posts
Decorative boards	Bubble Gamma Delta Theta Decor-Mat	Stainless steel Stainless steel Glass Glass Polycarbonate	1790 x 150 1790 x 300	Composite boards (Classic, XL, Platinum) Alu boards (Classic)	Basic post Clamp post
	LED Light	LED Light bar	n/a		

ACCESSORIES FOR LED LIGHT

	Type	Detail
Power supply	24 W	up to 2 LED lights
	36 W	up to 3 LED lights
	60 W	up to 6 LED lights
Extension cables	length 500 mm	with 1 or 2 exits
	length 2200 mm	with 1 or 2 exits
	length 6000 mm	with 1 or 2 exits

Compatible products

- HoriZen Composite & Aluminium boards
- Basic post & Clamp post

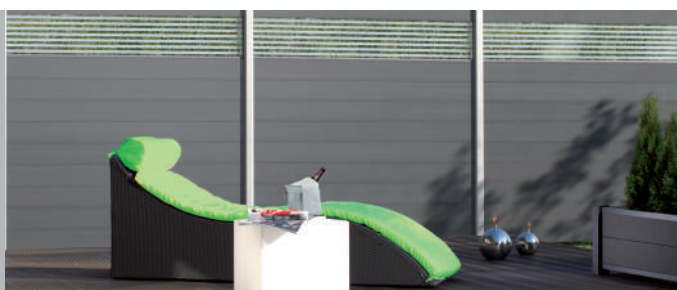





HoriZen® Composite Design Alu panel

Privacy solutions

Privacy panel, made out of Composite XL boards, pre-mounted in an aluminum frame. A stylish combination for a natural or modern look.

Product detail

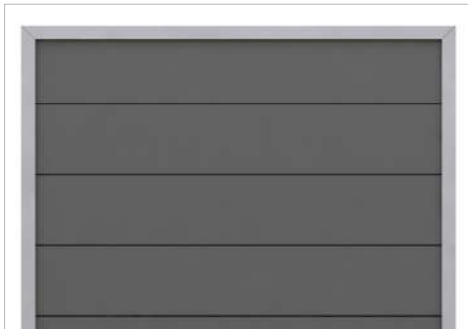

BENEFITS

Aluminum & Composite

Panel made out of composite boards in an aluminum frame. No maintenance required.

Rigid & easy to install

Easy to install. A specific steel post system is available, with a simple fixation system.

Attractive range

2 attractive composite board colors, mounted in a modern silver coated aluminum frame. 3 standard panel sizes available. Non-standard panels can be made on request. A compatible range of single & double swing gates is available.

Applications



Functionalities



HoriZen composite design alu assortment

Privacy panel

- 2 different Composite XL board colors:
 - anthracite
 - sand
- mounted in a silver coated aluminum frame
- Standard panel sizes
 - 900 x 1800/900 mm
 - 900 x 1800 mm
 - 1800 x 1800 mm

Non standard panel sizes can be made on request (rectangular panels only)

- panel width : min. 400 mm
- panel height : min. 300 mm, max. 1800 mm



HoriZen Composite
Alu Design
anthracite



HoriZen Composite
Alu Design
sand

Posts & fixings



Steel post

- The panels are installed with a simple fixation system on polyester coated square steel post of 70 x 70 mm.
- The post is available
- in different lengths for installation
 - in concrete
 - on floor (the steel base plate is welded to the post).
 - in 2 standard colors : anthracite and silver.

Technical information

Panels

- WPC boards 1780 x 300 mm, with tooth-groove principle, anthracite or sand color
- Mounted in an aluminum frame 66 x 40 mm, polyester coated in silver
- Non-standard panel dimensions can be made on request

Posts

- Square rounded steel post, 70 x 70 mm
- Hot dip galvanized and polyester coated, anthracite or silver
- 10 year guarantee (cfr our quality policy)
- posts for installation on a wall, floor or terrace come with a welded floor plate

Accessoires

- Stainless steel screws and hooks for fixation of the panel to the steel post.
- Wind anchor



wind anchor

ASSORTMENT TABLE HORIZEN COMPOSITE ALU DESIGN BOARDS

Boards available colors	standard panel size (width x height) mm	fence height mm	Compatible posts Steel post 70 x 70 mm	
			in concrete mm	with welded base plate mm
anthracite sand	900 x 1800/900 slanted (1) 900 x 1800 (2) 1800 x 1800 (3)	for slanted panel side height 900	1500	1050
		for panel height 1800	2400	1950



1

2

3





HoriZen® Squadra Alu panel

Privacy solutions

Semi-transparent panel, made out of aluminum profiles, vertically mounted in a panel. For a modern and discrete privacy or front fence.

Product detail

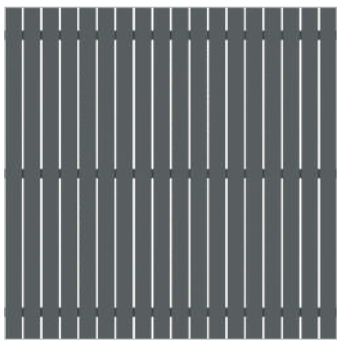

1800 x 1800 mm



900 x 1800 mm

BENEFITS

Aluminum

Polyester coated aluminum panel. Light weight, yet strong and corrosion resistant. No maintenance required.

Easy installation

Light and a very easy to handle & install. A specific steel post system is available, with a simple fixation system.

Large range

2 panel versions are available:

- Privacy panel : standard panel of 1800 x 1800 mm
- Front fence panel : standard panel of 900 x 1800 mm

Both panels are available in anthracite and light grey.

Non-standard panels can be made on request.

Applications



RESIDENTIAL

Functionalities



PRIVACY



DESIGN



DEMARCATIION

HoriZen squadra alu assortment

Privacy panel

- Aluminum panel, with vertical profiles
- Semi - transparant
- Standard panel size : 1800 x 1800 mm
- Non standard panel sizes can be made on request:
 - panel width : min. 200 – max. 2000 mm
 - panel height : min. 910 – max. 2000 mm
- Available in 2 colors:
 - Antracite
 - Light grey

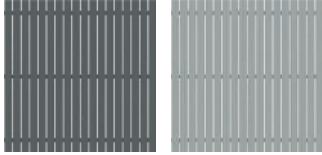

HoriZen Squadra Alu anthracite

HoriZen Squadra Alu light grey

Front fence panel

- Aluminum panel, with vertical profiles
- Semi - transparant
- Standard panel size : 900 x 1800 mm
- Non standard panel sizes can be made on request:
 - panel width : min. 200 – max. 2000 mm
 - panel height : min. 500 – max. 900 mm
- Available in 2 colors:
 - Antracite
 - Light grey

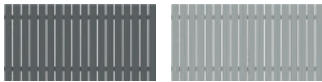

HoriZen Squadra Alu anthracite

HoriZen Squadra Alu light grey

Posts & fixings



Steel post

- The panels are installed with a simple fixation system on polyester coated square steel post of 70 x 70 mm.
- The post is available
- in different lengths for installation
 - in concrete
 - on a floor plate (the steel base plate is welded to the post).
 - in 2 standard colors : anthracite and silver.

Technical information

Panels

- Vertical aluminum profiles: 90 mm (wide) x 10 mm (thick)
- Horizontal aluminum profiles (mounted at one side of the panel): 15,5 x 50 mm
- The vertical profiles are invisibly mounted to the horizontal profiles (screws are covered by another profile).
- All aluminum profiles are polyester coated, in anthracite or light grey
- The panels are semi-transparent, and have a different front- and back side.

Posts

- Square rounded steel post: 70 x 70 mm
- Hot dip galvanized and polyester coated, anthracite or light grey
- Post for installation on floor have a welded base plate
- 10 year guarantee (cfr our quality policy)

Accessories

- Stainless steel screws and hooks for fixation of the panel to the steel post.
- Wind anchor



wind anchor

ASSORTMENT TABLE HORIZEN SQUADRA ALU PANELS

	available colors	standard panel size (width x height) mm	fence height mm	Compatible posts Steel post 70 x 70 mm	
				in concrete mm	with welded base plate mm
Privacy panel	anthracite light grey	1800 x 1800	1800	2400	1950
Front fence panel		900 x 1800	900	1500	1050



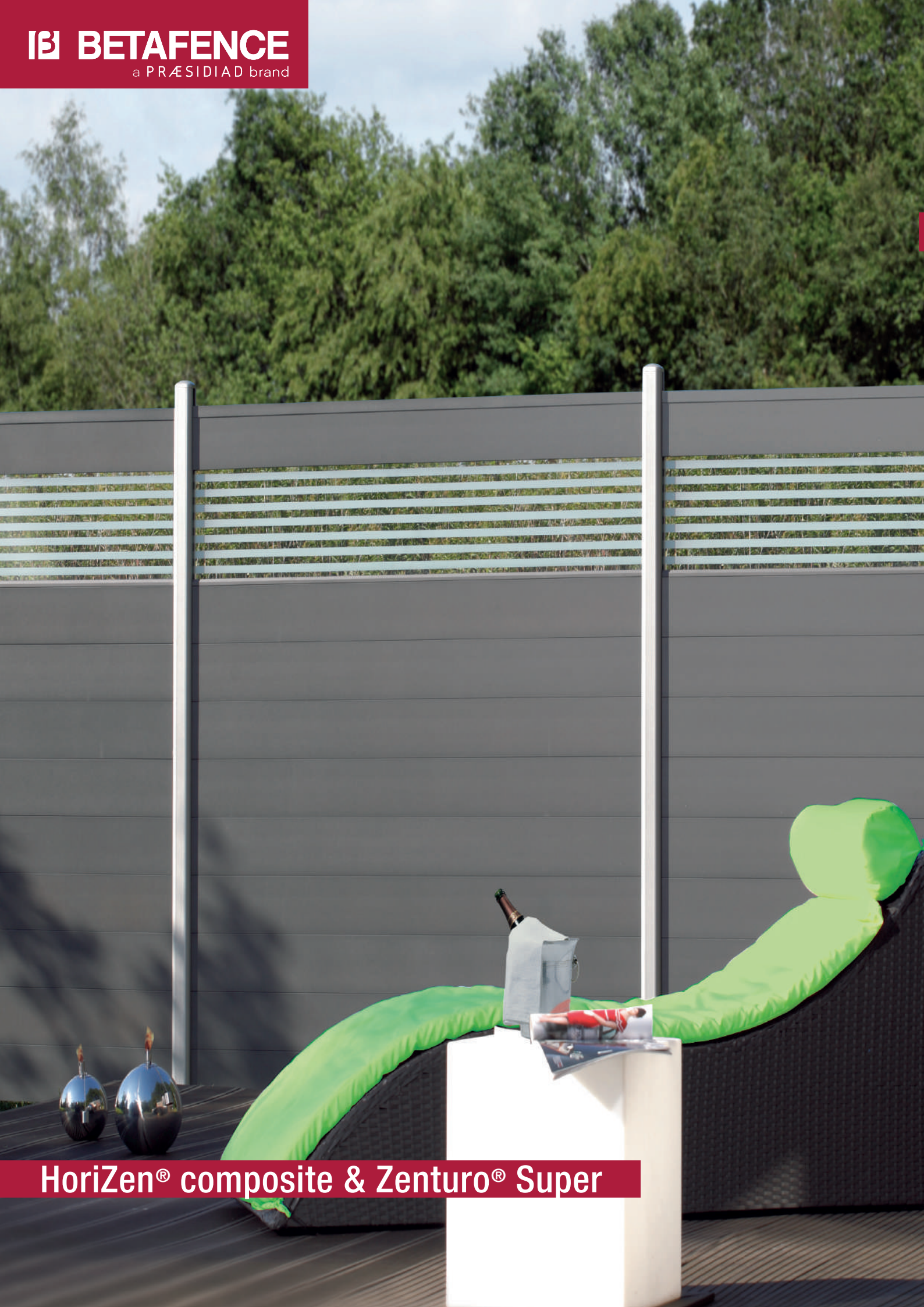

HoriZen® composite & Zenturo® Super

Faldivia® speed folding gate



Bekafor® Classic swing gate

Gates

Bekafor Classic swing gates are available in single and double version with Bekafor Classic infill for perfect combination with Bekafor Classic panel fences.

Product detail

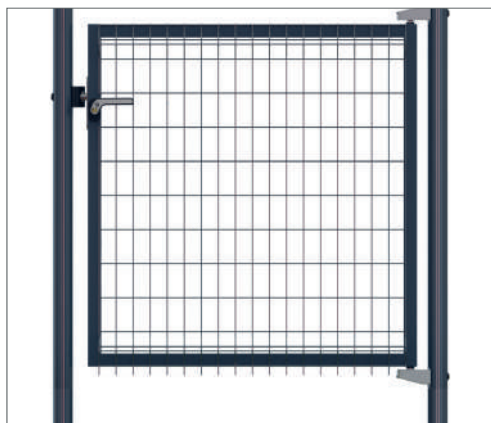

Applications



Functionalities



BENEFITS

- **Frame, Bekafor Classic infill and the post system are of an extremely rigid construction.**
- **The limited accessories permit a quick installation.**
- **Perfect fit with Bekafor Classic Panels. Panels are welded on the gateframe.**

Frame

- Frame out of square steel tubes, 40 x 40 mm, with welded Bekafor Classic infill.
- Steel plate thickness 1.50 mm

Posts

Each gate has 2 gate posts (included in the packaging). The Bekaclip posts are made out of welded tube with cap. Bekafor Classic panels can be fixed directly to the gate posts by means of Bekafor collars, diameter 60 mm, delivered with the gates.

Accessories

Bekafor Classic gates have a security lock and are provided with adjustable hinges for a perfect adjustment. The double gates are provided with a ground bolt in a ground bolt guider and a ground plate. The wing catcher, handles and ground bolt guider are made out of high quality plastic. The cylinder is integrated in the handle. The gates can be completed with a wooden Collfort infill to enhance privacy. A metal gate base plate is available for installing the posts on concrete or tiles.

Coating technique

Anti-corrosion treatment and high adherence polyester coating.



Colors

Green RAL 6005 and anthracite BF 7016M.

ASSORTMENT BEKAFOR CLASSIC SINGLE SWING GATES**

Width mm	Height mm	Wing width mm	Distance between posts (center/center) - mm	Overall width mm
1000	1030	966,5	1100	1160
1000	1230	966,5	1100	1160
1000	1530	966,5	1100	1160
1000	1730	966,5	1100	1160
1000	2030	966,5	1100	1160

ASSORTMENT BEKAFOR CLASSIC DOUBLE SWING GATES**

Width mm	Height mm	Wing width mm	Distance between posts (center/center) - mm	Overall width mm
3000	1030	1466,5	3095	3155
3000	1230	1466,5	3095	3155
3000	1530	1466,5	3095	3155
3000	1730	1466,5	3095	3155
3000	2030	1466,5	3095	3155

** up to wing-height 1230 mm: overhangs are pointed downwards

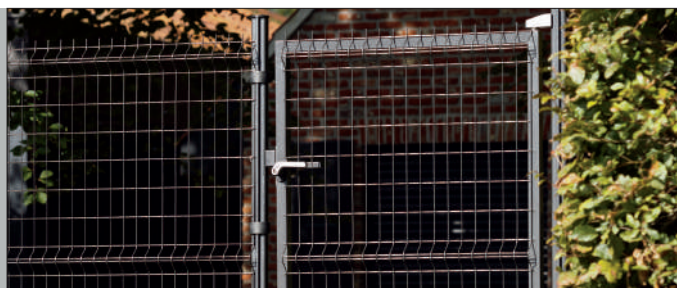

Bekafor® Essential swing gate

Gates

The Bekafor Essential gates are available in single wing. Ideal for combination with the Bekafor panels and Pantanet rolls.

Product detail



Applications



Functionalities



BENEFITS

- The design is in perfect harmony with the Bekafor and Pantanet panels.
- Frame, infill and post system are of a very rigid construction.
- The limited accessories allow a quick installation.
- Bekafor Essential swing gates receive the best anti-corrosion coating available: the gates receive a protective coating, then a polyester coating that reaches the highest norms in the field of gloss, hardness and adhesion.

Frame

- Frame out of square steel tubes, 40 x 40 mm, with welded mesh, 100 x 50 mm, infill.
- Steel plate thickness 1.50 mm

Posts

Each gate has 2 gate posts (included in the packaging). The Bekaclip posts are made out of welded tube with cap. Bekafor panels can be fixed directly to the gate posts by means of Bekafor collars, diameter 60 mm, delivered with the gates. Pantanet can be fixed to the gate posts by means of clips or binding wire.

Panel infill frame

The panel with mesh of 100 x 50 mm is welded into the gate frame.

Coating technique

Anti-corrosion treatment and polyester coated.



Colors

RAL 6005 and BF 7016M.

ASSORTMENT OF SWING GATES BEKAFOR ESSENTIAL

Width mm	Height mm	Free passage between the posts - mm	Gate posts profile mm	Posts length mm
1000	1000	1050	60 x 2	1500
1000	1200	1050	60 x 2	1750
1000	1500	1050	60 x 2	2000
1000	1800	1050	60 x 2	2400



Zenturo® Super swing gate

Gates

Zenturo Super single swing gates are ideal for a stylish entrance. The frame infill perfectly matches the Zenturo style, for both version, Classic & Super.

Product detail

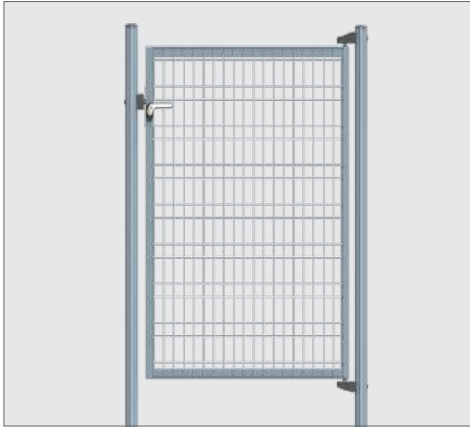

Applications



Functionalities



BENEFITS

- The frame, the Zenturo Super infill and the post system are very robust.
- The Zenturo Super gate is equipped with a design and secure lock and hinge system:
 - a small, discreet, integrated lock with safety anchor (all stainless steel)
 - secure, aesthetic handles with integrated key cylinder
 - high quality lock fitting in a discreet design
 - black metallic hinges, in a contemporary design and in line with the handles
- Can be combined with Zenturo Classic and Zenturo Super fencing systems.

Frame

Frame made of square tube 40x40 mm with welded-on Zenturo Super panel.

Gate infill

The gate infill consists of a Zenturo Super wire mesh panel, with mesh sizes 100x50/50x50 mm and with alternating horizontal wires.

Accessories

Zenturo Super swing gates feature 2 gate posts, diameter 60 mm (Bekaclip posts), with associated collars, diameter 60 mm, to fix the Zenturo panels to the gate posts.

The gate accessories (lock/handles/gate fitting/hinges) offer various additional benefits in terms of quality, security and design.

All accessories are included in the packaging of the gate.

A specific accessory to fix the gate directly on a wall is available.

Coating technique

Galvanised and polyester plastic coated.



Colors

Anthracite grey BF7016M

ASSORTMENT SINGLE ZENTURO SUPER SWING GATES

Width - mm	Height mm	Distance between posts mm	Number of Bekafor collars
1000	955	1090	6
1000	1255	1090	6
1000	1555	1090	6
1000	1705	1090	8
1000	2005	1090	8



Decofor® swing gate

Gates

The Decofor single and double swing gates are a perfect combination with the decorative Decofor Arco and Recto panel fences.

Product detail

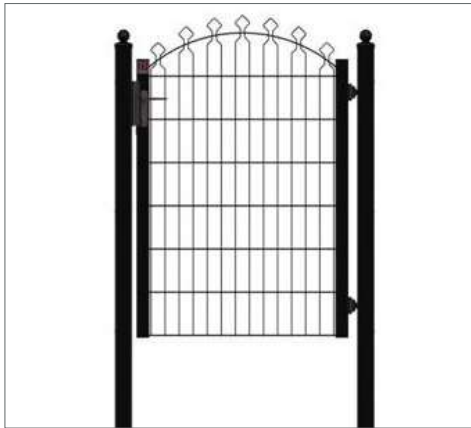

Applications



Functionalities



BENEFITS

- The design is in perfect harmony with the Decofor panels Arco and Recto.
- Frame, infill and post system are of a very rigid construction.
- The limited accessories allow a quick installation.
- Decofor gates receive the best anti-corrosion coating available: the gates receive a protective coating, then a polyester coating that reaches the highest norms in the field of gloss, hardness and adhesion.

Frame

- The gate frame is made out of rectangular steel tube with a profile of 60 x 40 mm.
- Adjustable hinges allow the wings to be opened 180°.
- Lock systems composed of a lock slot, a counter lock, integrated lock with cylinder and handle.
- The double gates are supplied with a ground bolt to be anchored into the central floor plate.

Posts

- Profile :
- single gates : 80 x 80 x 3 mm
 - double gates: 100 x 100 x 3 mm

They are adapted to the different heights of fences and completed with a metal ball cap. They are supplied with inserts for the fixation of the fencing panels.

Panel infill frame

Decofor Arco panel with mesh of 200 x 65 mm is welded into the gate frame. Gates with Decofor Recto on request.

Accessoires

For wall fixation special hinges are available.

Coating technique

Galvanised and polyester coated.



Colors

Black RAL 9005

ASSORTMENT OF SWING GATES DECOFOR ARCO

Width mm	Height mm	Free passage mm	Gate posts profile mm	Posts length mm
Single Swing Gates				
1120	886	1040	80 x 80 x 3	1300
1120	1086	1040	80 x 80 x 3	1500
1120	1286	1040	80 x 80 x 3	1800
1120	1486	1040	80 x 80 x 3	2000
Double Swing Gates				
3720	886	3620	100 x 100 x 3	1300
3720	1086	3620	100 x 100 x 3	1500
3720	1286	3620	100 x 100 x 3	1800
3720	1486	3620	100 x 100 x 3	2000



CreaZen® swing gate

Product detail



Applications



Functionalities



Gates

The CreaZen gates are available as single and double swing gates. The CreaZen infill fits harmoniously with the CreaZen railing system.

BENEFITS

- The design is in perfect harmony with the CreaZen panels.
- Rigid and qualitative construction.
- With aesthetic and high quality stainless steel accessories.
- Universal 180° opening

Frame

The gate frame consists of steel tubes, 60x40 mm, which are welded at both sides of the CreaZen panel. This results in a very rigid construction. The complete frame is hot dip galvanized and PES coated.

Posts

Each gate has got 2 gate posts, which are included in the packaging. Standard the posts are to be put into concrete. Posts with welded floor plates are available on request.

Post section:

For single gates: 100x100x3 mm | For double gates: 120x120x3 mm

The gate posts are hot dip galvanized and PES coated and have got a plastic cap. Standard post include inserts to enable fixation of CreaZen panels.

Accessories

A box containing all accessories is included with each gate:

- built-in lock with stainless steel cover plates
- symmetrical European cylinder, with 3 keys
- strong hinges, fully reversible left/right and allowing 180° opening of the gate wing.
- decorative handles
- gate catcher installed on the post or wing)

Coating technique

Both gate wing(s) and posts are hot dip galvanized and PES coated.



Colors

Anthracite RAL 7016, other colors are available on request.

ASSORTMENT CREAZEN SWING GATES

Width mm	Height mm	Wing width mm	Post length (installation in concrete) mm	Distance between posts (centre/centre) mm	Overall width mm
Single swing gates					
1200	1000	1200	1600	1340	1440
	1200		1800		
	1500		2100		
	1700		2300		
	2000		2600		
Double swing gates					
4000	1000	2x2000	1600	4180	4300
	1200		1800		
	1500		2100		
	1700		2300		
	2000		2600		







Barofor® swing gate

Gates

The Barofor gates are available as single and double swing gates. The Barofor infill fits harmoniously with the Barofor railing system.

BENEFITS

- The design is in perfect harmony with the Barofor panels: Square-Round-Deco
- Rigid and qualitative construction.
- With aesthetic and high quality stainless steel lock.
- Universal 180° opening

Product detail



Square



Deco



Round

Applications



Functionalities





Build-in Lock

Frame

The gate frame consists of steel tubes, 60x60x1.5 mm, which are welded at both sides of the Barofoor panel. This results in a very rigid construction. The complete frame is hot dip galvanized and PES coated.

Posts

Each gate has got 2 gate posts, which are included in the packaging. Standard the posts are to be put into concrete. Posts with welded floor plates are available on request.

Post section:

80x80x2 mm (available with or without baseplates)

The gate posts are hot dip galvanized and PES coated and have got a plastic cap. The posts are standard foreseen with holes to enable fixation of Barofoor panels.

Accessories

A box containing all accessories is included with each gate:

- build-in lock with stainless steel cover plates
- symmetrical European cylinder, with 3 keys
- strong hinges, fully reversible left/right and allowing 180° opening of the gate wing.
- aluminum handles
- gate catcher installed on the post or wing
- ground bolt for double swing gates

Coating technique

Both gate wing(s) and posts are hot dip galvanized and PES coated.



Colors

Anthracite RAL 7016, Green RAL 6005, Black RAL 9005, other colors are available on request.



Hinge system

ASSORTMENT BAROFOOR SWING GATES

Nominal height (mm)	Nominal width 1-wing (mm)	Nominal width 2-wing (mm)
Assortment Barofoor Square		
1000	1000 / 1500	2000 / 3000 / 4000
1200		
1500		
1800		
2000		
2400		
Assortment Barofoor Round		
1000	1000 / 1500	2000 / 3000 / 4000
1200		
1500		
1800		
2000		
2400		
Assortment Barofoor Deco		
1000	1000 / 1500	2000 / 3000
1200		
1500		





HoriZen® system Swing gates

Access control

Complete assortment of single & double swing gates with HoriZen Composite or Aluminium board panels.

Product detail



single swing gates



double swing gates

BENEFITS

Composite or Aluminium infills

For a perfect match with the privacy fence, all swing gates can be ordered with the available Composite & Aluminium boards.

High quality

- Rigid steel and/or Aluminium frame construction
- Mitre corners
- Qualitative Aluminium gate hardware, with built-in lock

Large & flexible range

Swing gates are available with all Composite & Aluminium boards. Standard size of the single swing gate: 98 x 180 cm. All swing gates (single & double wing) can be ordered to the required gate width or height. Frame & gate posts are available in both anthracite & silver. Wings for left or right opening are available.

Easy & flexible installation.

Easy installation, inside/outside & left/right 180° opening

Applications



Functionalities



Frame

- Standard single swing gates (980 x 1800 mm)
 - Aluminium frame, profiles 60 x 40 mm
 - Mitre construction
 - Polyester coated frame in anthracite or silver
- Non-standard single swing gates & all double swing gates
 - Welded steel frame, profiles 60 x 40 mm
 - Hot dip galvanized & polyester coated frame in anthracite or silver
 - With Aluminium anodized and polyester coated profiles (to hold the infills)

Posts

- Set of 2 gate posts, for single or double gates
- Steel profile of 80 x 80 mm
- Hot dip galvanized & polyester coated in anthracite or silver
- Post length 2550 mm, for installation in concrete

Infills

- HoriZen Composite
 - Classic (sand, almond, anthracite & grey)
 - XL (anthracite & grey)
 - Platinum (brown & grey)
- HoriZen Aluminium
 - Classic (anthracite & silver)

Range

- Single swing gates
 - Standard size : 980 x 1800 mm
 - Non- standard sizes:
 - * single swing gates wing width between 900 and 1800 mm
 - * max. wing height 1800 mm
- Double swing gates:
 - Max. double wing width 3600 mm, max. wing height 1800 mm
 - Non-symmetrical wing widths are possible

Accessoires

- Build-in lock, compatible with any kind of cylinder
- 2 decorative Aluminium handle sets: handle/handle or handle/knob
- U-profile : for fixation of Composite & Aluminium boards directly to the gate posts (available in anthracite & silver)



Handles



Handle & doorknob

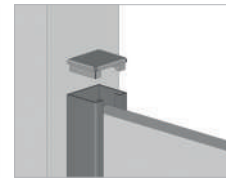

U-profile



Lock

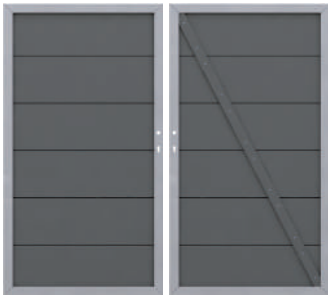

single swing gates



double swing gates

ASSORTMENT TABLE STANDARD HORIZEN SINGLE SWING GATES

Infill	Type	Boards available colors	Gate frame available colors	Gate posts available colors	wing width mm	wing height mm	post distance (center/center) mm	required space mm
Composite	Classic	anthracite grey almond sand	anthracite silver	anthracite silver	980	1800	1090	1170
	Platinum	grey brown						
	XL	anthracite grey						
Aluminium	Classic	anthracite silver						





Fortinet® swing gate

Gates

The Fortinet single and double swing gates harmonises perfectly with different fences on rolls: Pantanet, Fortinet and Plasitor.

Product detail



BENEFITS

Classic design

The Fortinet swing gate is meticulously finished: the frame is fully mitre welded and finished with elegant Fortinet mesh infill. Gate hardware (lock, handles & hinges) is unique of its kind and offers the Fortinet swing gate a discrete, yet contemporary design.

Rigidity

All elements of the Fortinet swing gates have a very strong construction: frame, gate infill, posts & gate hardware.

Safety & security

The strong construction of wings and posts, combined with the rigid & high quality hardware, results in a safe and secure solution. The unique lock system avoids a locked gate from being forced and opened.

Fast installation

Fortinet gates are designed for a fast installation. The required accessories & tools are limited to a minimum.

Applications



RESIDENTIAL

Functionalities



ACCESS
CONTROL

Frame

The gate frame is made out of square steel tube with a profile of 40 x 40 mm.

With Betafence-brand plate.

Mesh infill frame

Fortinet mesh with square mesh of 50x50 mm is welded into the gate frame. The horizontal wires have a crimp at every mesh.

Posts

The posts are adapted to the different gate & fence heights and finished with a plastic cap.

Coating techniques

The Fortinet swing gate receives a protective anti-corrosion layer and is finished with a polyester coating with a perfect adhesion.

Colors

Green RAL 6005 / Black RAL 9005 (selected range) / Anthracite 7016 (selected range).

Hardware

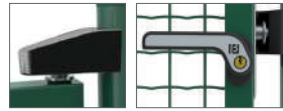

The unique lock system with integrated cylinder lock and nicely designed handles & latch offers a secure, yet discrete & appealing solution. The gates are provided with stylish black-silver hinges, matching perfectly with the design of the handles.

All hardware is made out of rustproof materials (stainless steel, aluminum & high quality plastics).



The Fortinet double swing gates are provided with a ground bolt and ground plate.



A gate base plate is available for installation of the gates with posts diam. 60 mm, on concrete or tiles.

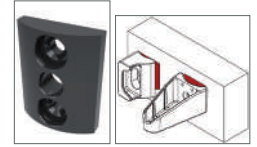

An accessory is available for installation of the Fortinet swing gate with the latch or with the hinges directly to a wall.

For double gates 3000 x 1750 / 1950 mm and 4000 x 1750 / 1950 mm an adapted ground bolt system and square posts are foreseen

ASSORTMENT FORTINET SINGLE SWING GATES

Width mm	Height mm	Distance between posts mm	Distance c/c posts mm	Needed space mm	Ø Gate posts mm
1000	750	920	980	1040	60
1000	950*	920	980	1040	60
1000	1150*	920	980	1040	60
1000	1450*	924	1000	1076	76
1000	1750*	924	1000	1076	76
1000	1950*	924	1000	1076	76
1250	950	1170	1230	1290	60
1250	1150	1170	1230	1290	60
1250	1450	1174	1250	1326	76
1250	1750	1174	1250	1326	76
1250	1950	1174	1250	1326	76
1500	950*	1460	1520	1580	60
1500	1150*	1460	1520	1580	60
1500	1450*	1464	1540	1616	76
1500	1750*	1464	1540	1616	76
1500	1950*	1464	1540	1616	76
2000	950	1960	2020	2080	60
2000	1150	1960	2020	2080	60
2000	1450	1964	2040	2116	76
2000	1750	1964	2040	2116	76
2000	1950	1964	2040	2116	76

* These gate types are also available in black (RAL 9005) and anthracite (RAL 7016).



ASSORTMENT FORTINET DOUBLE SWING GATES

Width mm	Height mm	Distance between posts mm	Distance c/c posts mm	Needed space mm	Ø Gate posts mm
2000 (1000 + 1000)	950*	1804	1880	1956	76
2000 (1000 + 1000)	1150*	1804	1880	1956	76
2000 (1000 + 1000)	1450*	1804	1880	1956	76
2000 (1000 + 1000)	1750*	1800	1880	1960	80
2000 (1000 + 1000)	1950*	1800	1880	1960	80
2250 (1000 + 1250)	950	2054	2130	2206	76
2250 (1000 + 1250)	1150	2054	2130	2206	76
2250 (1000 + 1250)	1450	2054	2130	2206	76
2250 (1000 + 1250)	1750	2050	2130	2210	80
2250 (1000 + 1250)	1950	2050	2130	2210	80
2500 (1250 + 1250)	950	2304	2380	2456	76
2500 (1250 + 1250)	1150	2304	2380	2456	76
2500 (1250 + 1250)	1450	2304	2380	2456	76
2500 (1250 + 1250)	1750	2300	2380	2460	80
2500 (1250 + 1250)	1950	2300	2380	2460	80
2500 (1000 + 1500)	950*	2349	2425	2501	76
2500 (1000 + 1500)	1150*	2349	2425	2501	76
2500 (1000 + 1500)	1450*	2349	2425	2501	76
2500 (1000 + 1500)	1750*	2345	2425	2505	80
2500 (1000 + 1500)	1950*	2345	2425	2505	80
2750 (1250 + 1500)	950	2599	2675	2751	76
2750 (1250 + 1500)	1150	2599	2675	2751	76
2750 (1250 + 1500)	1450	2599	2675	2751	76
2750 (1250 + 1500)	1750	2595	2675	2755	80
2750 (1250 + 1500)	1950	2595	2675	2755	80
3000 (1500 + 1500)	950*	2894	2970	3046	76
3000 (1500 + 1500)	1150*	2894	2970	3046	76
3000 (1500 + 1500)	1450*	2894	2970	3046	76
3000 (1500 + 1500)	1750*	2890	2970	3050	80
3000 (1500 + 1500)	1950*	2890	2970	3050	80
3000 (1000 + 2000)	950	2849	2925	3001	76
3000 (1000 + 2000)	1150	2849	2925	3001	76
3000 (1000 + 2000)	1450	2849	2925	3001	76
3000 (1000 + 2000)	1750	2925	2925	3005	80
3000 (1000 + 2000)	1950	2925	2925	3005	80
3250 (1250 + 2000)	950	3099	3175	3251	76
3250 (1250 + 2000)	1150	3099	3175	3251	76
3250 (1250 + 2000)	1450	3099	3175	3251	76
3250 (1250 + 2000)	1750	3095	3175	3255	80
3250 (1250 + 2000)	1950	3095	3175	3255	80
3500 (1500 + 2000)	950	3394	3470	3546	76
3500 (1500 + 2000)	1150	3394	3470	3546	76
3500 (1500 + 2000)	1450	3394	3470	3546	76
3500 (1500 + 2000)	1750	3390	3470	3550	80
3500 (1500 + 2000)	1950	3390	3470	3550	80
4000 (2000 + 2000)	950	3894	3970	4046	76
4000 (2000 + 2000)	1150	3894	3970	4046	76
4000 (2000 + 2000)	1450	3894	3970	4046	76
4000 (2000 + 2000)	1750	3890	3970	4050	80
4000 (2000 + 2000)	1950	3890	3970	4050	80

* These gate types are also available in black (RAL 9005) and antracite (RAL 7016).





Egidia swing gates

Gates

The Egidia swing gates offer an excellent price/quality rate and can be combined with multiple fencing systems.

Product detail



BENEFITS

Universal opening

The Egidia swing gate can open to the left or to the right and inside or outside (except for wings with 3D panel infill, which can only be opened to the right or to the left.)

Easy and quick installation

Egidia gates are designed for an easy and quick installation.

Multi-infill

The rigid construction of the wings can have different infills, with the same posts & accessories. There are 3 possible types of gates with each different infills:

- **Egidia SQ20** with welded bars infill of 20 x 20 mm
- **Egidia 3D** with welded 3D panel infill
- **Egidia M50** with welded mesh of 50 x 50 x 4 mm

Universal wings

The same wings can be used for both single as double swing gates.

Applications



Functionalities



Frame

Rigid and high quality construction out of square tube 40 x 40 mm.

Posts

Square posts out of welded tubes of 60 x 60 mm, with PVC cap

Coating technique

Egidia swing gates are galvanised according to DIN EN ISO 1461 and polyester coated.



Colors

Green RAL 6005/Anthracite RAL 7016. For design M50, gates are also available from stock in black RAL 9005

Content of accessory box for single and double swing gate

single gate	double gate	
2	4	Complete hinge
1	1	Slamplate + stainless steel M8 x 25 bolts
-	1	Lock holes cover + stainless steel M6 x 25 bolts
1	1	Lock handles and washers (by pairs)
1	1	Lock and cylinder + stainless steel M6 x 20 bolts
-	1	Groundbolt (standard delivered without groundplate)
4	4	Plugs to cover extra hinge holes in the posts Ø 17
3	3	Plugs to cover inserts

CE marking

These gates are provided with a CE label. This means Betafence guarantees the gate has been produced following the CE Regulations, as specified in the EU Construction Products Regulation (N° 305/2011).



A specific Declaration of Performance (DoP) is available for this type of gate with number DoP- Beta-011. The number is written on the CE label and the contents of this Declaration of Performance can be consulted and printed from the web page: betafence.net/en/ce-documentation.

Ordering

These Egidia SQ20 / 3D / M50 can be ordered by:

- **Seperate components:** wings, posts, accessory boxes
- **Kit:** complete gate
- **Set:** pre-assembled gate (only for single Egidia M50 swing gates)

Options

- Groundplate for groundbolt

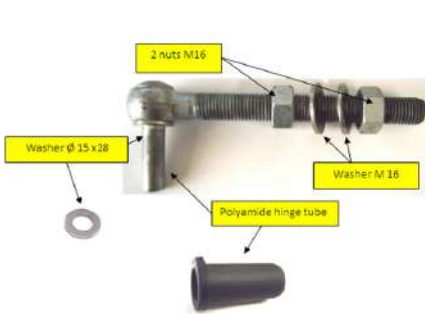

Complete hinge



Slamplate



M8 x 25 mm



lock and cylinder + stainless steel M6 x 20 mm

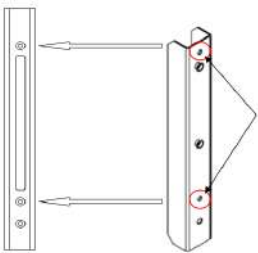

lock holes cover



stainless steel M6 x 25 mm



lock handles & washers (by pairs)



ground bolt



plugs to cover the extra hinge holes



plugs to cover inserts



Pre-assembled gates = Sets

- Lock and Lock keeper, installed
- All the caps plugged it
- Hinges adjusted and fixed
- Handles packed next to the gate
- Packed one per palette
- Available only in limited range of single gates.
- Gate is ready to be put in the concrete with labor cost reduction.

Complete gate (not pre-assembled) = Kits

- Based on picking of required elements in our stock (posts, wings, accessories)
- Gate to be assembled by customer
- Packed one per palette
- Whole range of 1 & 2 wings gates available

Components

- Sold as full pallets only.
- Wings: 6 per palette; Posts: 24 pairs/palette; Accessories 12 boxes/box

ASSORTMENT EGIDIA SINGLE SWING GATES

Nominal Width mm	Nominal Height mm	Real Height mm	Gate posts mm	Gate post length mm	Free passage mm	Distance c/c posts mm	SQ20*	3D**	M50
1200	1000	1050	60 x 60 x 1,5	1700	1180	1240	x	-	x
	1200	1250	60 x 60 x 1,5	2000			x	-	x
	1400	1450	60 x 60 x 2	2100			-	-	-
	1500	1550	60 x 60 x 2	2300			x	x	x
	1600	1650	60 x 60 x 2	2300			-	-	-
	1700	1750	60 x 60 x 2	2500			x	x	x
	1800	1850	60 x 60 x 2	2500			x	-	-
	2000	2050	60 x 60 x 2	2700			x	x	x
1500	1000	1050	60 x 60 x 1,5	1700	1530	1590	x	-	x
	1200	1250	60 x 60 x 1,5	2000			x	-	x
	1400	1450	60 x 60 x 2	2100			-	-	-
	1500	1550	60 x 60 x 2	2300			x	x	x
	1600	1650	60 x 60 x 2	2300			-	-	-
	1700	1750	60 x 60 x 2	2500			x	x	x
	1800	1850	60 x 60 x 2	2500			x	-	-
	2000	2050	60 x 60 x 2	2700			x	x	x

* Distance between the vertical welded infill bars inside the gate frame: 110 mm - ** Gates height < 1.50 have barbed oriented to the bottom

ASSORTMENT EGIDIA DOUBLE SWING GATES*

Nominal Width mm	Wing width mm	Nominal Height mm	Real Height mm	Gate posts mm	Gate post length mm	Free passage mm	Distance c/c posts mm	SQ20	3D**	M50
2400	2 x 1200	1000	1050	60 x 60 x 1,5	1700	2320	2380	x	-	x
	2 x 1200	1200	1250	60 x 60 x 1,5	2000			x	-	x
	2 x 1200	1400	1450	60 x 60 x 2	2100			-	-	-
	2 x 1200	1500	1550	60 x 60 x 2	2300			x	x	x
	2 x 1200	1600	1650	60 x 60 x 2	2300			-	-	-
	2 x 1200	1700	1750	60 x 60 x 2	2500			x	x	x
	2 x 1200	1800	1850	60 x 60 x 2	2500			x	-	-
	2 x 1200	2000	2050	60 x 60 x 2	2700			x	x	x
2700	1200 + 1500	1000	1050	60 x 60 x 1,5	1700	2670	2730	x	-	x
	1200 + 1500	1200	1250	60 x 60 x 1,5	2000			x	-	x
	1200 + 1500	1400	1450	60 x 60 x 2	2100			-	-	-
	1200 + 1500	1500	1550	60 x 60 x 2	2300			x	x	x
	1200 + 1500	1600	1650	60 x 60 x 2	2300			-	-	-
	1200 + 1500	1700	1750	60 x 60 x 2	2500			x	x	x
	1200 + 1500	1800	1850	60 x 60 x 2	2500			x	-	-
	1200 + 1500	2000	2050	60 x 60 x 2	2700			x	x	x
3000	2 x 1500	1000	1050	60 x 60 x 1,5	1700	3020	3080	x	-	x
	2 x 1500	1200	1250	60 x 60 x 1,5	2000			x	-	x
	2 x 1500	1400	1450	60 x 60 x 2	2100			-	-	-
	2 x 1500	1500	1550	60 x 60 x 2	2300			x	x	x
	2 x 1500	1600	1650	60 x 60 x 2	2300			-	-	-
	2 x 1500	1700	1750	60 x 60 x 2	2500			x	x	x
	2 x 1500	1800	1850	60 x 60 x 2	2500			x	-	-
	2 x 1500	2000	2050	60 x 60 x 2	2700			x	x	x

*double swing gates are a combination of the existing single swing gates - ** Gates height < 1.50 have barbed oriented to the bottom





Robusta® Nylofor® swing gate

Access control

The Robusta Nylofor swing gates are available in single and double version with Nylofor infill as a perfect combination with Nylofor panel fences.

Product detail

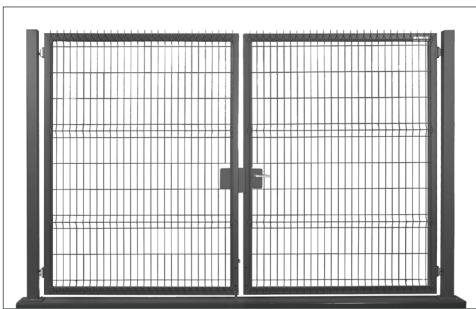

BENEFITS

Rigid construction

All elements of the Robusta Nylofor swing gates are of an extremely rigid construction: frame, Nylofor panels and post system.

Optimal setting

The locking system allows optimal adjustment and is easy to install.

Universal opening

The hinges are adjustable and allow each leaf to swing through 180°. All hinges are positioned symmetrically. Thanks to this, you can change your way of opening the gate while installing the wing (except for Nylofor 3D infill).

High quality coating

The Robusta Nylofor swing gates receive the best coating available.

Rapid installation

The Robusta Nylofor swing gates are designed for quick installation: the accessories are limited to a minimum.

Secure adjustable lock

External lock with secure adjustable latch.

Applications



PUBLIC SPACES
& BUILDINGS



OFFICE
BUILDINGS



FACTORIES &
LOGISTICS

Functionalities



ACCESS
CONTROL



Frame

Frame out of square tube

Mitre welded 60 x 60 or 60 x 40 mm, with welded Nylofor panel on the frame (for 3D panels) or in the frame (for 2D panels). For gates with Nylofor 3D panel infill and height < 1730 mm: barbes are pointing downwards.

Posts

Square posts out of welded tube with cap.

Dimensions: 80 x 80 x 2; 80 x 80 x 3; 100 x 100 x 3; 140 x 140 x 3; 160 x 160 x 5

Components

- **Hinges:** adjustable, allow the gate wings to open through 180°.
- **Lock system:** external secure lock system, with adjustable latch.
- **Ground bolt:** manufactured from HDG and attached to the wing, to be anchored into the central floor plate.
 - Standard on double swing gate: 1 ground bolt
 - Additional ground bolt for single or double gates: optional.
- **Ground stop** will be delivered with double gate.

CE Marked

Robusta Nylofor swing gates are CE marked according to the European regulation: Construction products regulations (CPR) (EU-305/2011) and type tested according to standard EN 13241-1 for industrial, commercial, garage doors and gates.



Coating technique

Galvanised and polyester coated.

Colors

Green RAL 6005, white RAL 9010, black RAL 9005, anthracite grey RAL 7016. Other colors on request.

Options



Gate catcher



Fence connection strip



Fence connection clip



Ground bolt



Ground stop

ASSORTMENT ROBUSTA NYLOFOR 3D SWING GATES

Width mm	Height mm	Free passage mm	Overall width mm
Single swing gates			
1000	1030/1230/1530/1730/2030/2430	985	1145
1200	1030/1230/1530/1730/2030/2430	1255	1415
1500	1030/1230/1530/1730/2030/2430	1525	1685/1685/1685/1685/1685/1725
2000	1030/1230/1530/1730/2030/2430	2065	2265
2500	1030/1230/1530/1730/2030/2430	2470	2670/2670/2670/2670/2750/ 2750
3000	1030/1230/1530/1730/2030/2430	3010	3210/3210/3290/3290/3290/3290
4000	1030/1230/1530/1730/2030/2430	3955	4235/4235/4235/4235/4235/4275
4500	1030/1230/1530/1730/2030/2430	4495	4775/4775/4775/4775/4815/4815
5000	1030/1230/1530/1730/2030/2430	5070	5350/5350/5350/5390/5390/5390
Double swing gates			
2000	1030/1230/1530/1730/2030/2430	1930	2090
2400	1030/1230/1530/1730/2030/2430	2470	2630
3000	1030/1230/1530/1730/2030/2430	3010	3170/3170/3170/3170/3170/3210
4000	1030/1230/1530/1730/2030/2430	4090	4290
5000	1030/1230/1530/1730/2030/2430	4900	5100/5100/5100/5100/5180/5180
6000	1030/1230/1530/1730/2030/2430	5980	6180/6180/6260/6260/6260/6260
8000	1030/1230/1530/1730/2030/2430	7870	8150/8150/8150/8150/8150/8190
9000	1030/1230/1530/1730/2030/2430	8950	9230/9230/9230/9230/9270/9270
10000	1030/1230/1530/1730/2030/2430	10100	10380/10380/10380/10420/10420/10420

ASSORTMENT ROBUSTA NYLOFOR F/2D/2DSUPER SWING GATES

Width mm	Height mm	Free passage mm	Overall width mm
Single swing gates*			
1000	1030/1230/1430/1630/1830/2030/2430	985	1145
Double swing gates			
3000	1030/1230/1430/1630/1830/2030/2430	3010	3170/3170/3170/3170/3170/3210
4000	1030/1230/1430/1630/1830/2030/2430	4090	4290
5000	1030/1230/1430/1630/1830/2030/2430	4900	5100/5100/5100/5100/5180/5180/5180
6000	1030/1230/1430/1630/1830/2030/2430	5980	6180/6180/6260/6260/6260/6260/6260
8000	1630/1830/2030/2430	7870	8150/8150/8150/8190
10000	1630/1830/2030/2430	10100	10420

Robusta Nylofor 3D Super swing gates : assortment and dimensions available on request. *There are more dimensions available for our single swing gates. Please ask for our complete assortment.





Robusta® SQ25 swing gate

Access control

Single and double Robusta SQ25 swing gates with tubular infill, adapted posts, hinges, lock- and ground bolt system.

Product detail



BENEFITS

Rigid construction

All elements of the Robusta SQ25 swing gates are of an extremely rigid construction: frame, tubes and post system.

Security

The distance between the vertical bars is 110 mm, complying to the highest safety standards.

Optimal setting

The locking system allows optimal adjustment and is easy to install.

Universal opening

The hinges are adjustable and allow each gate wing to swing through 180°. All hinges are positioned symmetrically.

High quality coating

The Robusta SQ25 swing gates receive high quality coating.

Quick installation & exchange-ability

The Robusta SQ25 swing gates are designed for quick installation: the accessories are limited to a minimum.

Applications



Functionalities





Frame

Frame out of profile tube 60 x 40 or 60 x 60, with bars of 25 x 25 mm, mitre welded in the frame at a distance of 110 mm.

Posts

Square posts out of welded tube with cap.
Optional: welded fence connection strip or fence connection clips for the attachment of the panels to the gate posts by means of specific connection strips.

Components

- **Hinges:** adjustable, allow the gate wings to open through 180°.
- **Lock system:** external secure lock system, with adjustable latch.
- **Ground bolt:** manufactured from stainless steel and attached to the wing, to be anchored into the central floor plate.
 - Standard on double swing gate: 1 ground bolt
 - Additional ground bolt for single or double gates: optional.
- **Ground stop** will be delivered with double gate.

CE Marked

Robusta SQ25 swing gates are CE marked according to the European regulation: Construction products regulations (CPR) (EU-305/2011) and type tested according to standard EN 13241-1 for industrial, commercial, garage doors and gates.



Coating technique

Galvanised and polyester coated (min. 100 microns).

Colors

Green RAL 6005, white RAL 9010, black RAL 9005
Hot dip galvanised finish available.

Options



Gate catcher



Fence connection strips



Fence connection clip



Ground bolt



Ground stop
with slam plate

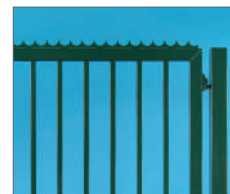

Dental strip

ASSORTMENT OF ROBUSTA SQ25 SINGLE SWING GATES

Width mm	Height mm	Free passage mm	Overall width mm
1000	1030/1230/1530/1730/2030/2430	985	1145
1200	1030/1230/1530/1730/2030/2430	1255	1415
1500	1030/1230/1530/1730/2030/2430	1525	1685/1725*
2000	1030/1230/1530/1730/2030/2430	2065	2265
2500	1030/1230/1530/1730/2030/2430	2470	2670/2750**
3000	1030/1230/1530/1730/2030/2430	3010	3210/3290***
4000	1030/1230/1530/1730/2030/2430	3955	4235/4275*
4500	1030/1230/1530/1730/2030/2430	4495	4775/4815**
5000	1030/1230/1530/1730/2030/2430	5070	5350/5390****

ASSORTMENT OF ROBUSTA SQ25 DOUBLE SWING GATES

Width mm	Height mm	Free passage mm	Overall width mm
2000	1030/1230/1530/1730/2030/2430	1930	2090
2400	1030/1230/1530/1730/2030/2430	2470	2630
3000	1030/1230/1530/1730/2030/2430	3010	3170/3210*
4000	1030/1230/1530/1730/2030/2430	4090	4290
5000	1030/1230/1530/1730/2030/2430	4900	5100/5180**
6000	1030/1230/1530/1730/2030/2430	5980	6180/6260***
8000	1030/1230/1530/1730/2030/2430	7870	8150/8190*
9000	1030/1230/1530/1730/2030/2430	8950	9230/9270**
10000	1030/1230/1530/1730/2030/2430	10100	10380/10420****

* height: 2430 mm

** heights: 2030 - 2430 mm

*** heights: 1530 - 1730 - 2030 - 2430 mm

**** heights: 1730 - 2030 - 2430 mm.

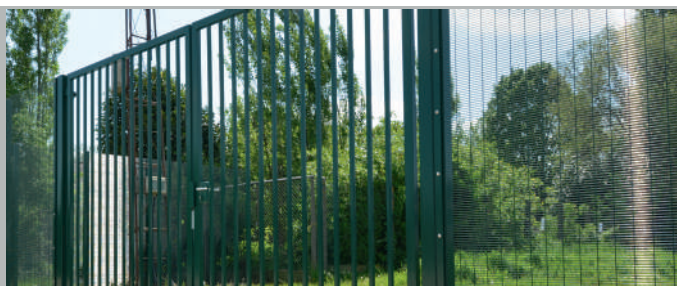



Robusta® Medium SQ20 swing gate

Access control

Single and double Robusta Medium SQ20 swing gates with light bar infill, that can be used with all kinds of fencing systems.

Product detail



BENEFITS

Rapid installation

The Robusta SQ20 swing gates are designed for quick installation. The accessories are limited to a minimum.

Good price/quality ratio

Qualitative construction suiting for normal use.

Security

The distance between the vertical bars is 110 mm. This satisfies the highest safety standards.

Secured closing

The stainless steel locking system is easy to install in all configurations. The 23 mm night pin assures a higher security level.

Adjustable hinges

Locinox hinge set with aluminum reinforced hinge post plugs for extra stability. The hinges are adjustable and allow each gate wing to swing through 90° opening.

High quality coating

The Robusta Medium SQ20 swing gates receive a high quality coating.

Applications



Functionalities



Frame

The frame of Robusta Medium SQ20 swing gates is manufactured from profile tubes: 40 x 40 mm or 50 x 50 mm with bars of 20 x 20 mm, welded at a distance of 110 mm.

Posts

Square posts with cap. Holes for hinges are pre-drilled.

Coating technique

Robusta Medium SQ20 swing gates are galvanised, followed by a polyester coating (min. 100 microns).



Colors

Green RAL 6005 and some heights also in anthracite grey RAL 7016. Hot dip galvanised finish available.

CE Marked

Robusta Medium SQ20 gates are CE marked according to the European regulation: Construction products regulations (CPR) (EU-305/2011) and type tested according to standard EN 13241-1 for industrial, commercial, garage doors and gates.



Accessoires



Hinges

The adjustable hinges enable a flexible gate opening. Both inside and outside openings are possible. Locinox hinge set with aluminum reinforced hinge post plugs for extra stability.



Lock

Aluminium lock and handle (green coated for green gates). External secure built on lock. Betafence logo is integrated.

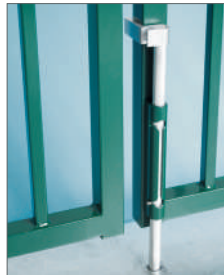

Ground bolt

Double swing gates are standard delivered with a ground bolt.

ASSORTMENT OF ROBUSTA MEDIUM SQ20 SINGLE SWING GATE

Width mm	Height mm	Section gatepost mm	Free passage mm	Needed space mm
1000	1000/1200	60x60x2	1030	1150
1000	1500/1700/2000	80x80x2	1030	1190
1500	1500/1700/2000	80x80x2	1550	1710
2000	1500/1700/2000	80x80x2	2070	2230

ASSORTMENT OF ROBUSTA MEDIUM SQ20 DOUBLE SWING GATE

Width mm	Height mm	Section gatepost mm	Free passage mm	Needed space mm
3000	1200	60x60x2	3070	3190
3000	1500/1700/2000	80x80x2	3070	3230
4000	1500/1700/2000	80x80x2	4110	4270
5000	1500/1700/2000	100x100x3	4930	5130
6000	2000	100x100x3	5970	6170





Robusta® Medium 2D swing gate

Access control

The Robusta Medium 2D gates offer an excellent price/quality rate and can be combined with multiple fencing systems.

Product detail



BENEFITS

Rapid installation

The Robusta Medium 2D swing gates with Nylofor 2D infill are designed for quick installation. The accessories are limited to a minimum.

Good price/quality ratio

Qualitative construction suiting for normal use.

Secured closing

The stainless steel locking system is easy to install in all configurations. The 23 mm night pin assures a higher security level.

Adjustable hinges

Locinox hinge set with aluminum reinforced hinge post plugs for extra stability. The hinges are adjustable and allow each gate wing to swing through 90° opening.

High quality coating

The Robusta Medium 2D swing gates receive a high quality coating.

Applications



Functionalities



Frame

Frame out of square tube 40 x 40 mm.

Posts

Square posts out of welded tube with PVC cap. With fence connection, enables the installation with all Betafence fencing systems. All corners possible with fence.

Coating technique

Robusta Medium 2D gates are galvanised according to DIN EN ISO 1461 – this guarantees a long life – and can be finished with a high quality Betafence polyester coating.



Colors

Hot dip galvanised finish available.
Green RAL 6005, green RAL 6009, anthracite grey RAL 7016 and black RAL 9005.

CE Marked

Robusta Medium 2D gates are CE marked according to the European regulation: Construction products regulations (CPR) (EU-305/2011) and type tested according to standard EN 13241-1 for industrial, commercial, garage doors and gates.



Accessoires



Lock system

Aluminum lock and handle. External secure built on lock system.



Hinges

The adjustable hinges enable a flexible opening of the gate. Both inside or outside openings are possible. Locinox hinge set with aluminum reinforced hinge post plugs for extra stability.



Ground bolt

Double gates are standard delivered with ground bolt.



Fence connection clips

The posts of the gates are foreseen with inserts to install fence connection clips to install the fencing to the gate. (Fence connection clips not standard included)

ASSORTMENT SINGLE SWING GATES

Width mm	Height mm	Posts mm	Distance between posts mm	Needed space mm
1000	800	60 x 60 x 2	1030	1150
1000	1000	60 x 60 x 2	1030	1150
1000	1200	60 x 60 x 2	1030	1150
1000	1400	80 x 80 x 2	1030	1190
1000	1600	80 x 80 x 2	1030	1190
1000	1800	80 x 80 x 2	1030	1190
1000	2000	80 x 80 x 2	1030	1190
1500	800	60 x 60 x 2	1550	1670
1500	1000	60 x 60 x 2	1550	1670
1500	1200	60 x 60 x 2	1550	1670
1500	1400	80 x 80 x 2	1550	1710
1500	1600	80 x 80 x 2	1550	1710
1500	1800	80 x 80 x 2	1550	1710
1500	2000	80 x 80 x 2	1550	1710

ASSORTMENT DOUBLE SWING GATES

Width mm	Height mm	Posts mm	Distance between posts mm	Needed space mm
3000	800/1000/1200	60 x 60 x 2	3070	3190
3000	1400/1600/1800/2000	80 x 80 x 2	3070	3230
4000	1000/1200/1400/1600/ 1800/2000	80 x 80 x 2 80 x 80 x 3	4110	4270





Robusta® SR sliding gate

Access control

Robusta SR sliding gates on rail offer optimal value for money, they have a proven reliability track and are used in various environments

Product detail



BENEFITS

Robust construction

Robusta gates have a robust frame and underbeam and have therefore guarantee a very secure operation.

Large execution range

Manual, motorizable or motorized versions are available. Various infills are possible. The gates can be perfectly combined with Robusta swing gates.

Proven reliability

The motorized gates are equipped with a qualitative European motor.

Plug and Play

Easy to install.

Security level



Applications



Functionalities



Possible executions

- Manual
- Motorizable
- Motorized: deadman key or automatic (including remote control)

Options

- Nylofor panels infills
- SEC flat infills
- Double guiding posts for Rail1500
- Dental strips
- Access control
 - Keypad
 - Keyswitch

Coating technique

Robusta gates are galvanised in- and outside according to EN10346 (Z275) and polyester coated (min. 100 micron).

Colors

Standard colors are RAL 6005, RAL 6009, RAL 9010, RAL 7030, anthracite grey RAL 7016 and RAL 9005. Other RAL colors available on request

CE Marked

Robusta gates are CE marked according to the European regulation: Construction products regulations (CPR)

(EU-305/2011) and type tested according to standard EN 13241-1 for industrial, commercial, garage doors and gates.

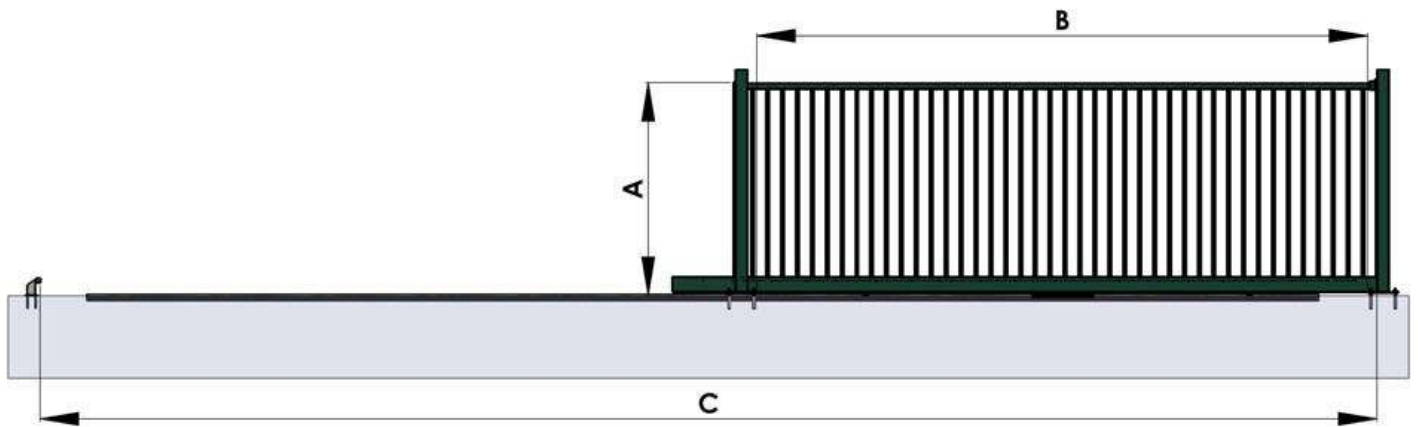

ASSORTMENT TABLE & TECHNICAL CHARACTERISTICS

Commercial width	3000 mm	4000 mm	5000 mm	6000 mm	7000 mm	8000 mm	9000 mm	10000 mm	11000 mm	12000 mm	13000 mm	14000 mm
Free passage (B)	2900	3900	4900	5950	6950	7950	8950	10000	11000	12000	13050	14050
Total needed space (C)	7280	9350	11350	13370	15390	17460	19460	21560	23630	25630	27650	29670
Nominal height mm	RAIL 1500 Dim. underbeam: 150 x 100 mm Infills: bars 25 x 25mm (diamond) (max distance 110mm) Guiding post: single End post: single, 120 x 80 120 x 120 (for height \geq 2m and or width \geq 8m)						RAIL 2000 Dim. underbeam: 200 x 100 mm Infills: bars 25 x 25mm (diamond) (max distance 110mm) Guiding post: double End post: double, 120 x 80					
Real height from foundation mm (A)	1200	1500	1700	2000	2400							
	1272	1572	1772	2072	2472							





Robusta® SC sliding gates

Access control

Robusta SC cantilever sliding gates are designed for “optimal value for money”, easy to install and can be used in various environments.

Product detail



BENEFITS

Robust construction

Robusta SC gates have a robust frame and underbeam and therefore guarantee a very secure operation. Two versions are available (underbeam R2000 and R2800), the choice of the underbeam is determined by the required free passage.

Large execution range

Manual, motorizable or motorized versions are available (manual/500/1000 line). Various infills are possible. The gates can be perfectly combined with Robusta swing gates.

Proven reliability

The motorized gates are equipped with a high qualitative European motor and all the necessary safety equipment.

Plug and play

Easy to install, the gate is delivered completely pre-assembled.

Security level



Applications



Functionalities





Possible executions

- Manual
- Motorizable: including inspection holes + dental rack
- Motorized: deadman key or automatic (including remote control and all necessary safety items)

Options

- Double guiding posts for R2000 (manual and motorizable)
- Dental strip

Coating technique

Robusta gates are galvanised in- and outside according to EN10346 (Z275) and polyester coated (min. 100 micron).

Colors

Standard colors are RAL 6005, RAL 6009, RAL 9010, RAL 7030, anthracite grey RAL 7016 and RAL 9005. Other RAL colors available on request

CE Marked

Robusta gates are CE marked according to the European regulation: Construction products regulations (CPR) (EU-305/2011) and type tested according to standard EN 13241-1 for industrial, commercial, garage doors and gates.

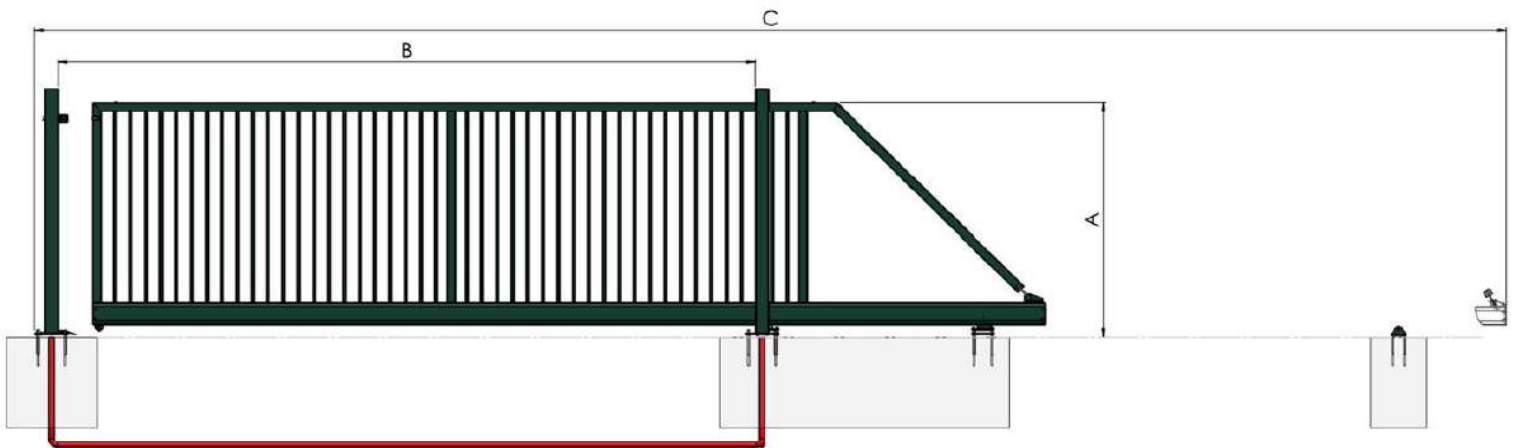

ASSORTMENT TABLE & TECHNICAL CHARACTERISTICS

Commercial width		3000 mm	4000 mm	5000 mm	6000 mm	7000 mm	8000 mm	9000 mm	10000 mm	11000 mm	12000 mm
Free passage (B) Manual		3232	4177	5122	6202	7282	8092	9172	10216	11431	11971
Free passage (B) Motorizable		3187	4132	5077	6157	7237	8047 (R 2000)	9127 (R 2000)	10171	11386	11926
Free passage (B) Automatic							8007 (R 2800)	9087 (R2800)	10131	11346	11886
Total needed space (C)		8058	10271	12298	14788	17093	19193	21948	23915	26500	27270
Nominal height mm	Real height from foundation mm (A)	R 2000 Dim. underbeam: 200 x 160 mm Frame: 80 x 60 mm Infills: bars 25 x 25 x 1,50 mm (square) (max distance between the bars is 110mm)						R 2800 Dim. underbeam: 280 x 200 mm Frame: H: 100 x 100 mm - V: 100 x 80 mm Infills: bars 30 x 30 x 1,50 mm (square) (max distance between bars is 105 mm)			
	1000	1072	Optional infill : Nylofor panels and SEC flat Guiding post: 120 x 80 x 3 mm 120*120 (for height >=2m and or width >=8m)						Optional infill : Nylofor panels and SEC flat Guiding post: double, 120 x 80 x 3 mm For automatic gates : guiding post is always single sided.		
1200	1272	For automatic gates : guiding post is always single sided.									
1500	1572										
1700	1772										
2000	2072										
2400	2472	R 2000 (characteristics same as R 2000 above)					R 2800 (characteristics same as R 2800 above)				



MECHANICAL SPECIFICATIONS OF ROBUSTA SC GATES

Type	R2000	R2800
Free passage Heights from 1,00 to 2,40 metres	3 to 9 metres	8 to 12 metres
Available versions	manual motorisable motorised (dead man key + full automatic)	
Gate wing construction		
Underbeam	200 x 160 x 5 mm	280 x 200 x 5 mm
Frame	80 x 60 x 3 mm	100 x 100 x 3 mm: horizontal 100 x 80 x 3 mm: vertical
tubular infill (standard)	25 x 25 x 1,5 mm	30 x 30 x 1,5 mm
Distance between bars	110 mm	105 mm
Locinox key lock	only for the manual gate	
Optional infill		
Nylofor panels or SEC flat	optional	
Guiding post		
manual and motorisable		
Type	single post bridge	double post bridge
Dimensions if height is less than 2 metres	120 x 80 x 3 mm	120 x 80 x 3 mm
Dimensions if height equal to or greater than 2 metres	120 x 120 x 3 mm and all heights from 8 metres	
Double sided guiding post	optional	
Guiding post		
motorised version		
Type	single post	single post
Dimensions	120 x 80 x 3 mm / 120 x 120 x 3 mm	200 x 100 x 4 mm
Lock post		
manual version		
Type	post in line	post in line
Dimensions	120 x 120 x 3 mm	120 x 120 x 3 mm
Lock post		
motorisable and motorised versions		
Types	double post bridge	
Dimensions	120 x 80 x 3 mm	120 x 80 x 3 mm
Dental rack on motorisable versions only		
Module	module 4	
Material	Steel-reinforced PA6	
Pre-installed	yes	

TECHNICAL SPECIFICATIONS FOR THE MOTORISATION OF ROBUSTA SC SLIDING GATES 746 ER = 500 LINE / 844 = 1000 LINE

Use	R2000		R2800
	Normal ⁽¹⁾	Intensive	Intensive
FAAC motorisation type	746	844	844
Controller reference	780D		
Number of photocells	2 sets		
Photocell heights (hardwired)	180 and 900 mm		
Pressure strips	Active ASO		
Number of pressure strips on the guiding post bridge	2		
Gate wing head pressure strip	Active		
Pressure strip on beam at the rear of the gate wing	not possible		
Warning light	1 PC		
Area lighting	optional		
Number of remote-controls supplied, 2 channels	2		
Number of controls available for dry contacts	2		

⁽¹⁾ Normal use : max. 50 cycles per day

Posts

All of our gates are supplied with a guiding post and lock post in single or double version. This according to the gate configuration. Please see table on previous page for further details.

Our cantilever gates are available in 4 different versions

R2000/2800 manual gate: our gate is designed for manual operation and will be fitted with a Locinox key-operated lock. The direction of opening can be reversed on site at the time of installation.

R2000/2800 motorisable gate (manual line): our gate is designed for the installation of an external motor later onwards.

R2000/2800 motorised gate (deadman key)(500 line): Due to our exclusive partnership with FAAC we can offer you a gate that is factory fitted with an external motor and no safety devices. The gate is operated by a dead man key switch. The gate operator is responsible for the safe working of the gate.

R2000 motorised gate (fully automatic)(500/1000 line):

R2800 motorised gate (fully automatic)(1000 line):

Due to our exclusive partnership with FAAC, we can offer you a gate that is factory fitted with an external motor and all necessary safety items and operating items. The gate is delivered fully pre-wired, and ready to operate. We offer two types here: motorisation for normal usage (500 line) and motorisation for intensive usage (1000 line) (the correct type should be determined by the amount of opening cycles / day)

Gate wing

- Welded frame
- Standard tubular infill (other infill possible as option)
- 2 sizes of underbeam are used according to the length of your gate and the chosen model
- Integrated tension system

Coating

Robusta SC sliding gates are protected by the best coating process currently available: galvanizing inside and out (min. thickness 275 g/m², 2 sides combined), followed by a polyester coating (minimum thickness of the layer : 100 microns).



Standard colors

Green RAL 6005, green RAL 6009, white RAL 9010, grey RAL 7030, grey RAL 7016, blue RAL 5010, black RAL 9005.
Other colors: on request.

CE marking

Robusta gates carry the C.E. mark, in accordance with the European directive. They are manufactured in accordance with the requirements of the directives (89/106/EC) and are tested according to EN 13241-1 specifications for industrial and commercial applications.



Robusta SC sliding gates

Robusta motorised SC sliding gates are available in two versions: Dead-man key or Fully automatic.

The Dead-man key version (500 line) comprises the FAAC motor, its control logic and a key switch, requiring no other safety devices on the gate.

The Fully automatic version (500/1000 line) comprises the FAAC motor and its control unit. It also comprises:

- **3 pressure strips** (active): contact with the pressure strips automatically reverses the movement of the gate.
- **Photocells:** the passage of the gate is monitored by two pairs of photocells as it closes. Activation will automatically reverse the movement of the gate.
- **Remote control:** the gate is provided with two 2-channel remote controls. Additional remote controls are possible, the system accepts up to 128 remote controls.
- **Warning light:** to warn that the gate is opening or closing.

Motor specification (normal or intensive use)

Supply voltage: 230 V AC

Rating:

- 746: 400 W (normal use - 500 line)
 - 844: 660 W (intensive use - 1000 line)
- Gate speed: 9 metres/min
Magnetic end stops

Easy installation

All our Robusta gates are fully pre-wired and ready to be quickly installed by professionals. The motor is mounted on a plate for attaching the motor to the guiding post. In the event of a power failure, the motor can be disengaged to enable manual opening.





Bekamatic® SC cantilever sliding gate

Access control

Bekamatic SC motorized cantilever sliding gate: “the expert gate” . Practical experience combined with Betafence superior technical know-how.

Product detail



BENEFITS

Developed for intense use

Very strong motorization and reliable gates for industrial use.

Special executions

Gates up to 4m high are possible, standard speed of 12m/min or variable speed up to 18 m/min (36 m/min for double gates).

Robust construction

Bekamatic gates have a very robust frame a strong under-beam and a double lock post.

Cabinet

The well designed high cabinet allows for various access control options. The cabinet is weather and vandalism proof.

Multiple possibilities

All infills are possible, gates width till 24 meters (double) and a full range of access control. This gate can be perfectly combined with a pedestrian gate.

Security level



Applications



Functionalities

Options

- Aluminium strips on upper beam
- Full access control: see PDF

Coating technique

Bekamatic gates are galvanised in- and outside according to EN10346 (Z275) then epoxy and polyester coated (min. 100 micron).

Colors

Standard colors are RAL 6005, RAL 6009, RAL 9010, RAL 7030, anthracite grey RAL 7016 and RAL 9005. Other RAL colors available on request

CE Marked

Bekamatic gates are CE marked according to the European regulation: Construction products regulations (CPR) (EU-305/2011) and type tested according to standard EN 13241-1 for industrial, commercial, garage doors and gates.

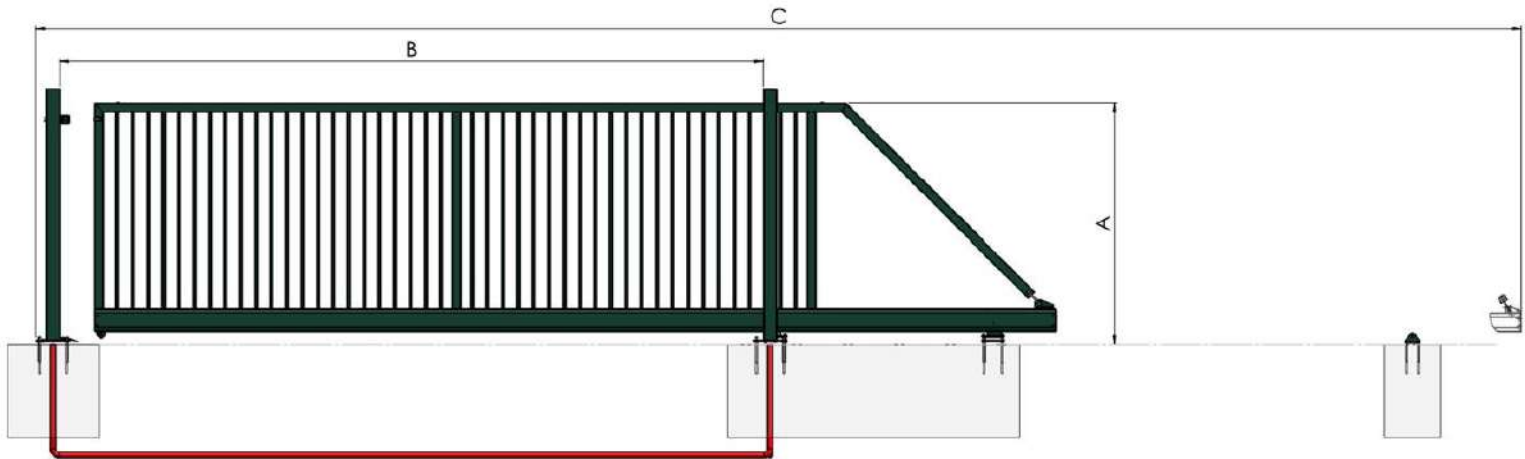

ASSORTMENT TABLE & TECHNICAL CHARACTERISTICS

Commercial width		3000 mm	4000 mm	5000 mm	6000 mm	7000 mm	8000 mm	9000 mm	10000 mm	11000 mm	12000 mm		
Free passage (B)		3157	4102	5047	6127	7207	8017	9097	10141	11356	11896		
Total needed space (C)		8058	10271	12298	14788	17093	19193	21948	23915	26500	27270		
Nominal height mm	Real height from foundation mm (A)	R 2000 Dim. underbeam: 200 x 160 mm Frame: 80 x 60 mm Infills: bars 25 x 25mm (square) (max distance 110 mm) Nylofor panels, Securifor panels						R 2800 Dim. underbeam: 280 x 200 mm Frame: H: 100 x 100 mm - V: 100 x 80 mm Infills: bars 30 x 30 (square) (max distance 105 mm) Nylofor panels, Securifor panels, Lamellas (width: 3-6m & height: 1-2,4m)					
	1000	1072											
	1200	1272											
	1500	1572											
	1700	1772											
	2000	2072											
	2400	2472	R 2000 (characteristics same as R 2000 above)						R 2800 (characteristics same as R 2800 above)				
		Guiding post: double - cabinet: 360 x 180 mm - External post: 180 x 80 mm End post: double 120 x 80 mm (no access control) 180 x 80 mm (with access control)											





Motorisation

For the motorisation, the motor/reductor is integrated in the guiding post. This type of automation guarantees a perfect operation in the most extreme conditions. A mechanical locking system prevents the gate from being opened manually once the gate has been automatically closed.

Manual unlocking system

A manual over-ride system disconnects the motor from the gate and permits manual opening and closing of the gate.

Controller (E145 or EP104)

Betafence is using a high-quality steering unit. A control unit with microprocessor manages the general functions and contains the control logic. A separate unit contains the special functions for access control.

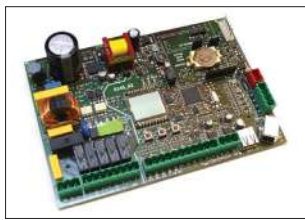

E145



EP104

Photocells

The gate passage is controlled by means of photocells installed on the guiding posts and end post. If the cells are activated, the gate will stop and open again.

Pressure strips

The front of the gate wing is fitted with a pressure strip. The guiding post of the Bekamatic gate is also fitted with 4 pressure strips: two at the front and two at the back side. Any contact with the pressure strips immediately stops and reverses the movement of the gate. At the street side one of the pressure strips can be replaced by a Securifor panel system.

Access control

The access control can be adapted to the special demands of the customer. A choice of multiple access control accessories are installed at the request of the customer: key switch, RF- remote control, proximity card reader, key pad, videophone/parlophone, timer clock, induction loop detector. These elements are installed on the guiding post, the lock post, or on a separate column on request.





Egidia[®] SC sliding gates

Access control

Egidia SC sliding gates are developed for industrial areas with frequent use. The design of the gate results in great value for money.

Product detail



BENEFITS

Large range

Egidia gates are available in several heights: from 1.00 to 2.4 m and widths: from 4 to 9 m.

Price/Quality

Egidia SC cantilever sliding gates offer an excellent price/quality ratio. The gate is designed to provide the best compromise between quality and price.

Design

The universal design of Egidia matches any type of fencing system.

Safety

The distance between the vertical bars is 110 mm, to prevent climbing through. Fitting the roller system in the underbeam also avoids accidents.

Complete system

The cantilever sliding gate can easily be used in conjunction with Egidia swing gates and the Betafence fencing system.

Security level

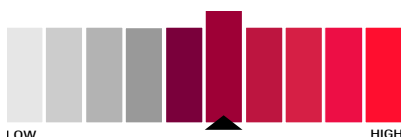

Applications

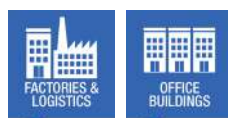

Functionalities



Gate wing

- Underbeam: 120 x 100 x 5 mm (welded to the wing's frame. Both are HDG afterwards)
- Lower profile of the frame: 80 x 60 x 2 mm (rest of frame 60 x 60 x 2 mm)
- Two rollersets with polyamide rollers are foreseen for each gate
- Locinox key-operated lock (standard foreseen for manual gates)
- Welded frame
- Integrated tension system



Possible executions

- **Manual gate:** our gate is designed for manual operation and is fitted with a key-operated Locinox lock.
- **Motorisable gate:** our gate is designed for the installation of an external motor later onwards. A dental rack is mounted on the beam and inspection plates are provided for the passage of wiring afterwards.
- **Motorised gate (fully automatic):** Due to our exclusive partnership with FAAC, we can offer you a gate that is factory fitted with an external motor and all necessary safety items and operating items. The gate is delivered fully prewired, and ready to operate. We offer two types of motorisation:
 - standard for intensive use: 500 line (except for 8 and 9 meters width, where we provide a 1000 line)
 - intensive use: 1000 line.

Infill

- Egidia sliding gates: are available with two types of infill:
 - Infill with profiles 20 x 20 x 1,5 mm (tubular)
 - Nylofor 3D panels, Max 2m. (the panels are screwed to the frame of the wing, using clamp + bolts)

Options

- Dental strip on top of the wing (only for height ≥ 2 m)
- Locinox key-operated lock (on motorisable gates)
- Plate to fix a padlock (on manual and motorisable gates)
- Handle is a standard in Locinox lock
- Key switch and / or keypad (battery powered)

Coating technique

Egidia gates are galvanised and PES powder coated. Also available as hot dip galvanised version.



Colors

Standard colors are RAL 6005, RAL 6009, RAL 9010, RAL 7030, anthracite grey RAL 7016 and RAL 9005. Other RAL colors available on request

CE Marked

Egidia SC sliding gates are CE marked according to the European regulation: Construction products regulations (CPR) (EU-305/2011) and type tested according to standard EN 13241-1 for industrial, commercial, garage doors and gates.

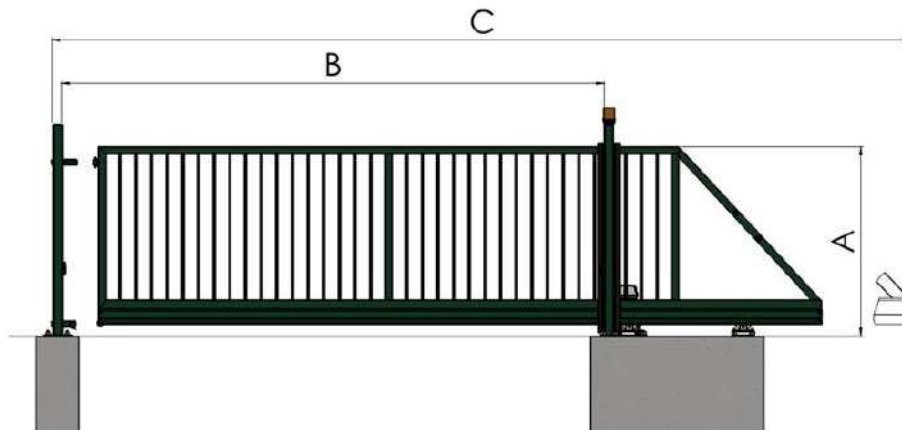

ASSORTMENT TABLE & TECHNICAL CHARACTERISTICS

Commercial width		4000 mm	5000 mm	6000 mm	7000 mm	8000 mm	9000 mm
Free passage (B)		4000	5000	6000	7000	8000	9000
Total needed space (C)		9600	11900	14200	16600	18900	21200
Nominal height mm	Real height from foundation mm (A)	Dim. underbeam: 120 x 100 mm Frame: Horizontal bottom: 80 x 60 mm Vertical + top: 60 x 60 mm Infills: tubular infills 20 x 20 mm, Nylofor 3D panel infills Guiding post: single, 120 x 80 mm End post: double, 80 x 80 mm					
1000	1067						
1200	1267						
1500	1567						
1700	1767						
2000	2067						
2400	2467						



Egidia SC cantilever sliding gates

Egidia SC motorised cantilever sliding gates are available in a fully automatic version.

The Fully automatic version comprises the FAAC motor and its control unit.

It also comprises:

- **3 pressure strips (active):** contact with the pressure strips automatically reverses the movement of the wing. The wing stops after 2 seconds.
- **Photocells:** the passage of the gate is monitored by 1 pair of photocells as it closes. Activation will automatically reverse the movement of the gate.
- **Remote-control:** the gate is provided with one 2-channel remote control. Additional remote-controls are possible, the system accepts up to 128 remote-controls.
- **Warning light:** to warn that the gate is opening or closing.

Motor specification

Normal or intensive use: 500 line

- Supply voltage: 230 V AC
- Rating: 746 ER: 400 W (intensive use)
- Gate speed: 9 metres/min
- Magnetic end stops

Intensive use: 1000 line

- Supply voltage: 230 V AC
- Rating: 844: 660 W (intensive use)
- Gate speed: 9 metres/min
- Magnetic end stops

Easy installation

All our Egidia gates are fully pre-wired and are ready to be quickly installed by professionals. The dental rack is installed on the underbeam. The motor is mounted on the guiding post. In the event of a power failure, the motor can be disengaged to enable manual opening.

TECHNICAL SPECIFICATIONS FOR THE MOTORISATION OF EGIDIA SC GATES

	Egidia SC 500 line	Egidia SC 1000 line
Use	Intensive	Intensive
FAAC motorisation type	746 ER 16	844
Voltage	230 V	
Power	400 W	660 W
Speed	9 metres/min	
Controller reference	780D	
Number of photocells	1 set	
Photocell heights (hardwired)	600 mm	
Pressure strips on the guiding post	2 active	
Gate wing head pressure strip	1 active	
Warning light	LED Light (orange)	
Number of remote-controls supplied, 2 channels	1	
Number of controls available for dry contacts	2	

MECHANICAL SPECIFICATIONS OF EGIDIA SC GATES

Free passage Heights from 1,00 to 2,40 metres	4 m - 9 m
Available versions	manual motorisable motorised
Gate wing construction	
Underbeam	120 x 100 x 5 mm + 80 x 60 x 2 mm
Frame	60 x 60 x 2 mm
tubular infill (standard)	20 x 20 x 1,5 mm
Distance between bars	110 mm
Built in lock	only for the manual gate
Optional infill	
3D Panels	optional (Max. 2,0m)
Guiding post	
Type	single sided guiding post (120 x 80 x 3 mm)
Lock post	
Type	double sided lock post (80 x 80 x 2 mm)
Dental rack for motorisable and motorised versions	
Type	module 4
Material	galvanized steel
Pre-installed	yes

Overview motorisation sliding gates

TYPE MOTOR	Use	Maximum speed	Bekamatic SC	Robusta SC	Robusta SR	Egidia SC
100 line	Normal (up to 30 cycles/day)	9 m/min			3-9 m	
500 line	Intensive (up to 60 cycles/day)	9 m/min	-	3-9 m	3-9 m	4-7 m 1000 line recommended for height 2,4m 1000 line mandatory for 8 & 9 meters width
1000 line	Intensive (up to 60 cycles/day)	9 m/min	-	3-12 m	3-14 m	4-9 m
6000 line	Heavy duty (up to 300 cycles/day)	12 m/min Variable speed	3-12 m	-	-	-
10000 line	Heavy duty (up to 300 cycles/day)	18 m/min Variable speed	3-12 m	-	-	-



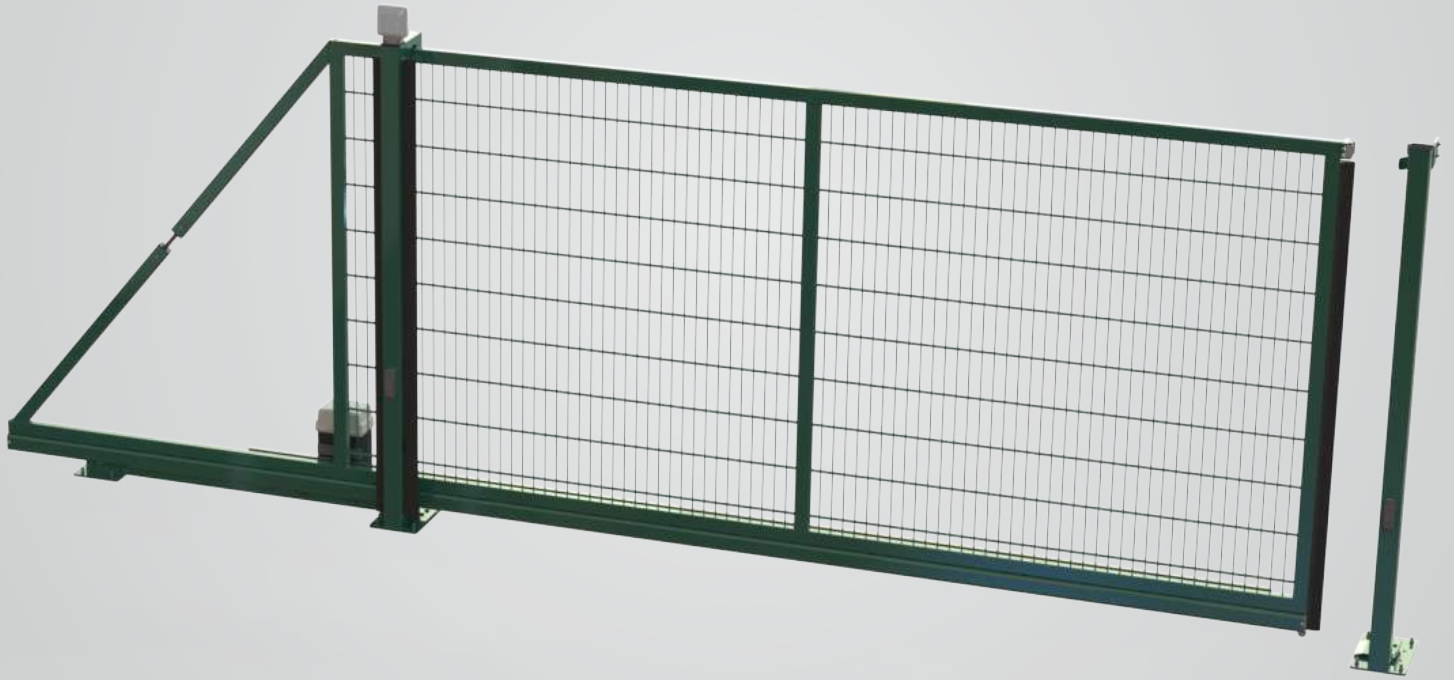

Egidia® SC Essential sliding gates

Access control

Egidia SC Essential sliding gates offer an excellent price/quality rate and are designed for frequent use in residential buildings and public areas.

Product detail

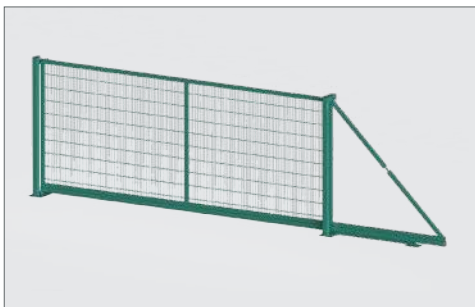

BENEFITS

Wide range

Egidia SC Essential gates are available in several heights: from 0,8 m to 2 m and widths: from 3 m to 5 m (in steps of 0,5 m).

Price/Quality

Egidia SC Essential cantilever sliding gates are designed to offer an excellent price/quality ratio.

Complete system

The cantilever sliding gate can easily be used in conjunction with Egidia Essential swing gates and the Betafence fencing system Nylofor 2DS/2D.

Security level

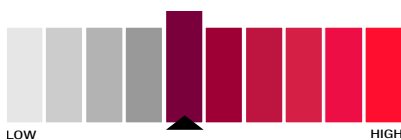

Applications



Functionalities



Gate wing

- Underbeam: 75 x 65 mm (screwed to the wing's frame)
- Frame: 60 x 40 mm
- Two rollersets with polyamide rollers are foreseen for each gate
- Locinox key-operated lock (standard foreseen for manual gates)
- Welded frame
- Integrated tension system

Variations of Egidia SC Essential gates

- **Manual gate:** our gate is designed for manual operation and is fitted with a key-operated Locinox lock.
- **Motorisable gate:** our gate is designed for the installation of an external motor later onwards. A dental rack is mounted on the lower beam of the frame and inspection plates are provided for the passage of wiring afterwards.
- **Motorised gate (fully automatic):** Due to our exclusive partnership with FAAC, we can offer you a gate that is factory fitted with an external motor and all necessary safety items and operating items. The gate is delivered fully pre-wired, and ready to operate.

Colors

Standard colors are green RAL 6005, anthracite grey RAL 7016.
Other RAL colors available on request.

Coating technique



Egidia SC Essential gates are galvanised and PES powder coated.

CE marked

Egidia SC sliding gates are CE marked according to the European regulation: Construction products regulations (CPR) (EU-305/2011) and type tested according to standard EN 13241:2003 + A2:2016 for industrial, commercial, garage doors and gates.



Motorised Egidia SC Essential gates

Egidia SC Essential motorised cantilever sliding gates are available in a fully automatic version. The Fully automatic version comprises the FAAC motor and its control unit. It also comprises:

3 pressure strips (active): contact with the pressure strips automatically reverses the movement of the wing. The wing stops after 2 seconds.

Photocells: the passage of the gate is monitored by 1 pair of photocells as it closes. Activation will automatically reverse the movement of the gate.

Remote-control: the gate is provided with one 2-channel remote control. Additional remote-controls are possible, the system accepts up to 128 remote-controls.

Warning light: to warn that the gate is opening or closing.

Motor FAAC specification

- Supply voltage: 230 V AC
- Gate speed: 9 metres/min
- Rating: 746 ER: 400 W
- Magnetic end stops

Easy installation

All our Egidia SC Essential gates are fully pre-wired and are ready to be quickly installed by professionals. The dental rack is installed on the lower beam. The motor is mounted on a separated plate screwed to the guiding post. In the event of a power failure, the motor can be disengaged to enable manual opening.

TECHNICAL SPECIFICATIONS A MOTORISED EGIDIA SC ESSENTIAL GATE

Type	Egidia SC Essential Automatic
Motor	FAAC 746 ER16
Controller Board	780D
Plug-in receiver	868MHz
Nr. of remote controls	1
Photocells	XP20W
Nr. of photocells	1 pair
Height of the photocells	600 mm
Warning Light	FAAC - XLED 24/230V (orange)
Safety edges	Active (ASO)
Nr./ Type of safety edges on GP	2 pc's ASO model SENTIR 65ST
Safety edges on front wing	ASO model SENTIR 65ST
Transmission system	JCM RADIOBAND

ASSORTMENT TABLE & TECHNICAL CHARACTERISTICS

Commercial width		3000 mm	3500 mm	4000 mm	4500 mm	5000 mm
Free passage [mm] (B)		3050	3550	4050	4550	4950
Total needed space [mm] (C)		7569	8569	9769	10869	11969
Nominal height [mm]	Real height from foundation [mm] (A)	Dim. Underbeam: 75 x 65 mm Frame: 60 x 40 mm Infills: Nylofor 2DS Single Guiding post: 80 x 80 mm Single Reception post: 80 x 80 mm				
800	876					
1000	1076					
1200	1276					
1400	1476					
1500	1576					
1600	1676					
1700	1776					
1800	1876					
2000	2076					

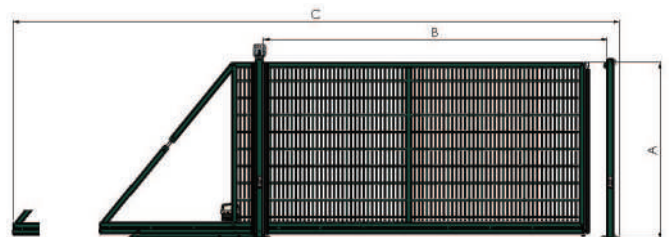



Faldivia®

speed folding gate
(trackless)

Access Control

The Faldivia trackless speed folding gate ensures that specific areas are closed off quickly. It is an extremely solid and rapid solution.

Product detail



BENEFITS

Fast and safe

The Faldivia speed folding gate opens and closes with a programmable speed up to 1 meter per second. The gates open inwards as standard. Once closed, the gate is magnetically locked, meaning that it is highly suitable for entrances with significant security requirements. The speed folding gate is fitted with cutting-edge safety technology: it stops automatically if an obstacle is in the way. The large hinges, which can be lubricated, ensure durable and safe operation.

Smart construction

The powerful gate motor is installed at the top of the post. The smart controls offer numerous programming options, as well as additional access control options.

Long lifetime

The gates are made out of steel, hot-dip galvanized (in accordance with EN ISO 1461) or hot-dip galvanized and powder coated. The gate is CE certified by TÜV for both the UK and all European markets.

Security level



Applications



Functionalities

Features

- Electrical cabinet equipped with controller and frequency converters.
- Additional optional access control elements - to be connected to the controller, such as an induction loop.
- Worm gear motor with hollow shaft, cast housing.
- Transmission via premium oil, meaning that operation is possible at very low temperatures.
- Drive power: 0.37 kW.
- The galvanised and polyester coated guiding arms are made from steel tubes and are attached to ball bearings.
- The guiding arms are galvanised and polyester coated. Available in any RAL color.
- Gate width up to 12 m.
- Height up to 4 m (with 8 m width) *Other dimensions on request.*
- Galvanised and plastic-coated posts, section 160 x 160 mm or 200 x 200 mm.

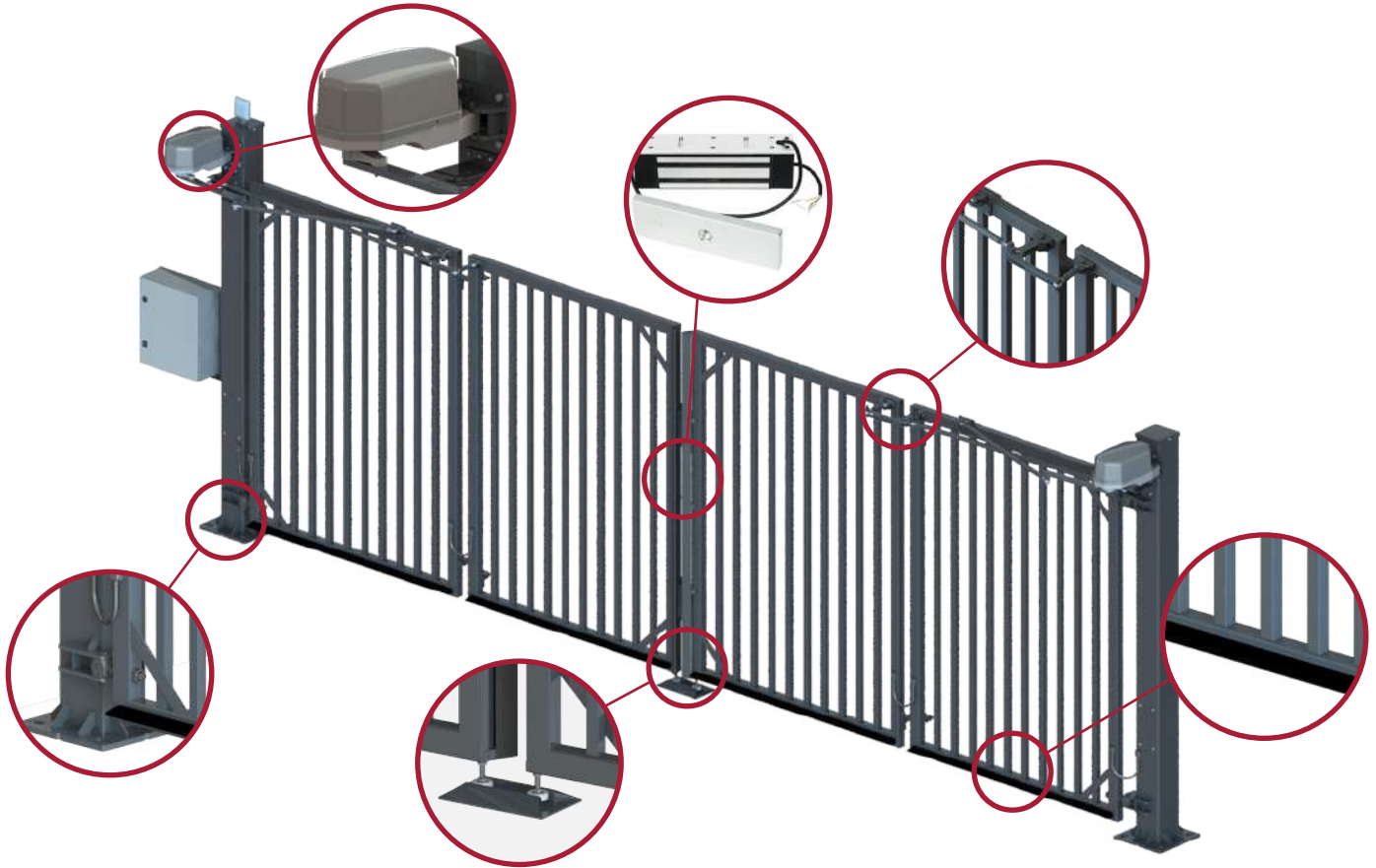

- Hinge rolled and milled from one single piece, designed for heavy gates and intensive use.
- Possibility to lubricate the rotation shaft, ensuring silent operation.
- Massive construction, with strong anti-corrosion finish and dual ball bearings ensure hassle-free operation under heavy loads.
- Strengthening ribs between post and base plate.
- Special Intermediate hinges can withstand vertical loads up to 2500 kg.
- Integrated lubrication system ensures reliability and silent operation in all conditions.
- IP 68 Electromagnetic lock with maximum pressure of 540 kg on closing, also keeps the gate in closed position.
- No moving mechanical parts.
- Automatic gate with warning light, safety strips and photocells.
- For gates > 6 m, two electromagnetic locks are installed, with total max. pressure of 1080kg.
- Gate in galvanized steel, optional polyester coating in chosen RAL color.
- Inner section of gate : square bars 40 x 40 mm. Securifor or Nylofor infill as an option.
- Gate frame: 80 x 60 mm or 100 x 100 mm.

CE Standard steel gates, protected against corrosion by hot-dip galvanizing in accordance with EN ISO 1461. The gate is CE certified by TÜV for both the UK and all European markets.



Technical description

Dimensions	Height: up to 4 m (with 8 m width) Width: up to 12 m*
Free passage	2 - 12 m
Opening/closing speed	Programmable speed up to 1m/s
External cabling	230V AC power supply
Electromagnetic lock	Maximum pressure 540kg (1080kg) on closing
Motorisation	Daab motor Drive power: 0.37 kW Frequency controller
Posts	160x160mm or 200 x 200 mm on base plate
Frame	Depending on the dimensions of the gate 80x60mm or 100x100 mm Inner section: bars with 40 x40 mm with max gap of 110 mm
Opening between gate and road surface	Min 125 mm
Colors	Available in a choice of RAL colors
Certification	CE certified by TÜV for both the UK and all European markets.
Standard safety features	6 safety strips in accordance with EN standard 13241 2 pairs of photocells 1 flashing light
Technical specification	PN-EN 13241-1+A2:2016 Industrial, commercial and garage doors and gates - Product standard - Part 1: Products without fire resistance or smoke control characteristics. Directives: 2006/95/EC; 2004/108/EC.

Product range

Width* (mm)	Height (mm)		
	2000	2400	up to 4000
Single gate - 1 W (2 sections)			
2000	✓	✓	✓
3000	✓	✓	✓
4000	✓	✓	✓
5000	✓	✓	
6000	✓	✓	
Double gate - 2 W (4 sections)			
4000	✓	✓	✓
5000	✓	✓	✓
6000	✓	✓	✓
7000	✓	✓	✓
8000	✓	✓	✓
9000	✓	✓	
10000	✓	✓	
11000	✓	✓	
12000	✓	✓	

* free passage

Optional equipment

- Key Switch
- Key Pad
- Dental strip
- Fence connection on the posts
- Inductive loops + loop detector
- Additional pair of photocells on separate columns
- Additional safety STOP buttons
- Additional remote controls
- Additional safety edges
- Traffic lights (red/green)
- Separate columns for access control
- GSM module for mobile phone opening
- Heating element
- Week/Year clock
- LED light to illuminate the free passage
- Other options on request





Turnstiles BT4

Access control

Betafence turnstiles are part of our access control product range that works in perfect combination with our professional fencing systems.

Product detail



BENEFITS

Simple and fast installation

The turnstile BT4 is composed of five separate components, which are easy to assemble. The position mounting on the floor is much easier when using the aluminum mold.

Long lifespan

The turnstile BT4 is made of highly durable weather and vandal resistant materials.

Operation and detection

Operation and detection of the turnstile BT4 is via contacts, IP (optional) or RS485 network.

2 variants

The turnstile BT4 is available with a 90° spindle for increased safety and larger passage capacity, and with a 120° spindle for a more comfortable passage.

Standard version

The standard version is available in two colors; dark grey (RAL7016) and light grey (RAL9006), such as displayed on the preview.

Security level



Applications



Functionalities



Frame or spindle

The frame and spindle consist of painted aluminum profiles.

Mechanism

- the spindle revolves when pushed by a visitor
- the rotation of the column is controlled by a self-centering system which automatically places the column in the next starting position after every cycle. This avoids intermediate positions of the spindle.
- in case of power failure, a person will never be trapped inside the turnstile.

Intelligent control unit

- setup and configuration adjustable to the customer's needs
- display for diagnose
- various operating modes for each passage or direction: free access, controlled access (entrance or exit priority possible) and locked
- counting pulse for every movement
- compatible with any access control system
- easy control and diagnostic over IP (optional) or RS485 network

Variants

- spindle of 90° or 120°

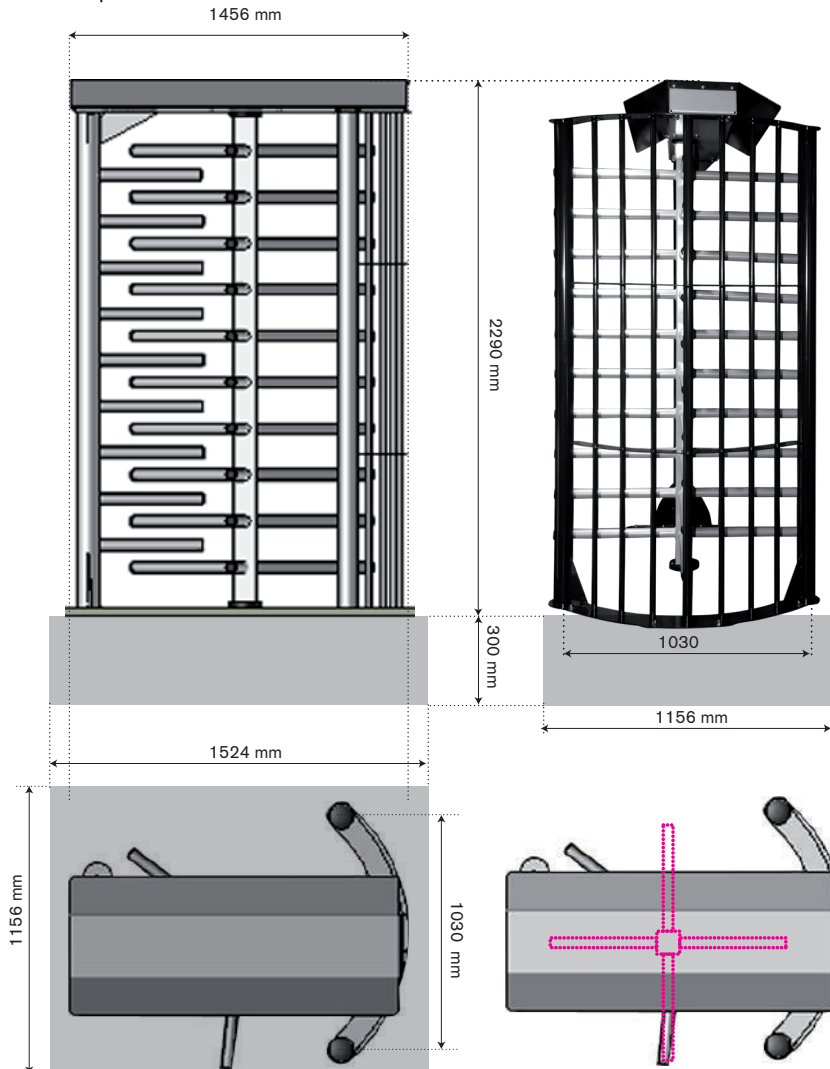

fundering

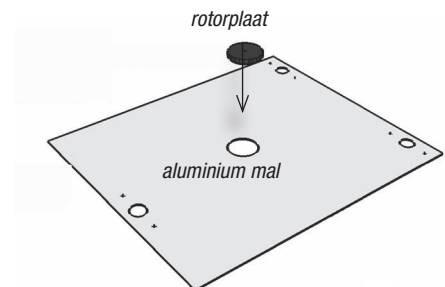

Extensions

- integrated access control

Maximum throughput

- 30/min for free passage
- 17/min at proximity

Options

For more options: please consult our salesbook

Power supply	240 Vac
Nominal current	1,2 A
Operating temperature	-15°C to +45°C



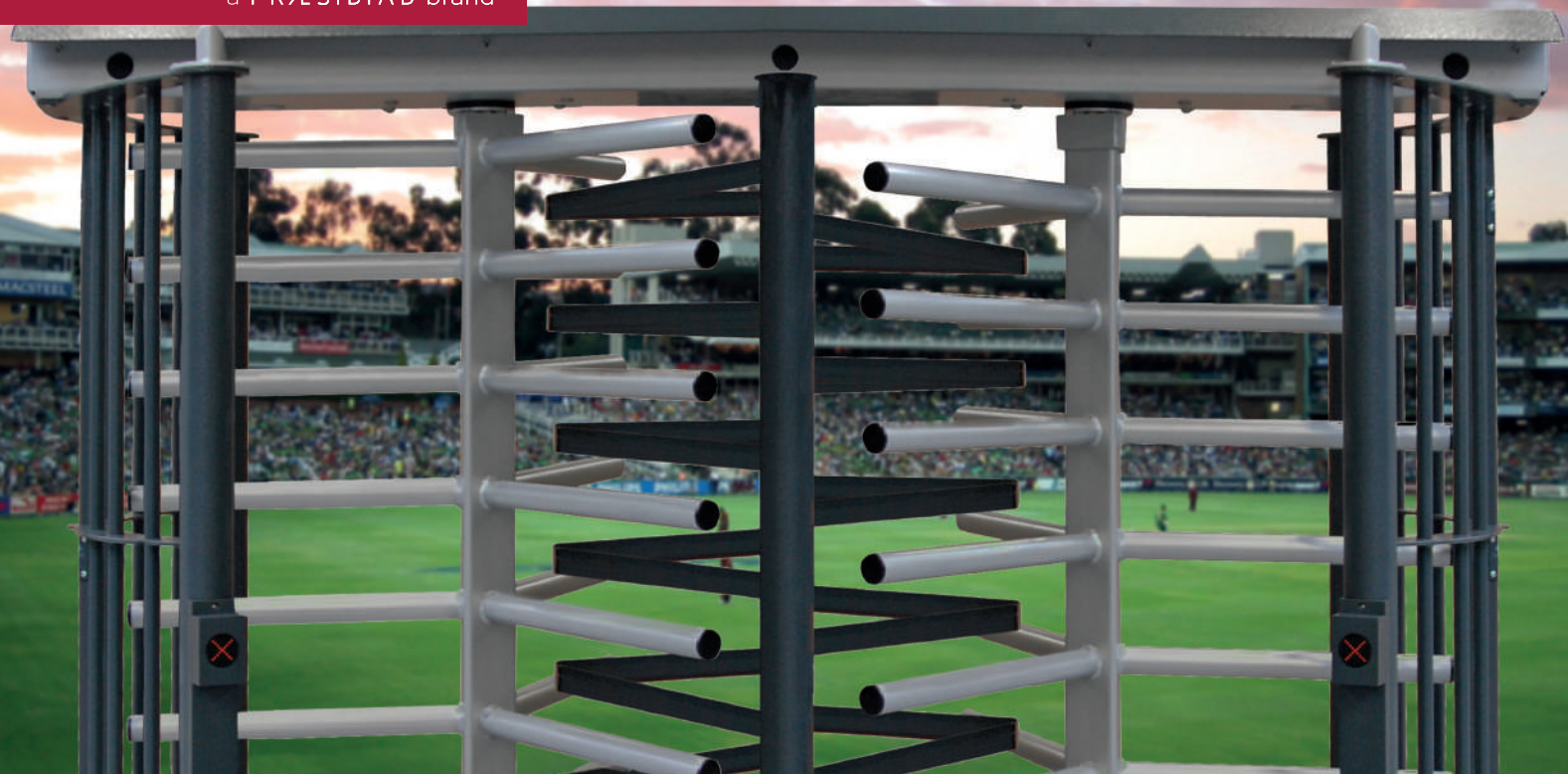

Turnstiles BT5

Access control

For a double streamlined, stylish passage.

Product detail

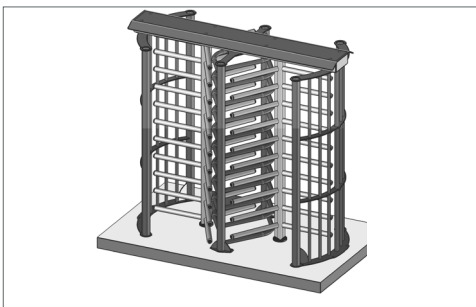

BENEFITS

Simple and fast installation

The turnstile BT5 is composed of five separate components, which are easy to assemble. Quick and correct positioning on the floor by using the aluminium mould.

Long lifespan

The turnstile BT5 is made of highly durable weather and vandal resistant materials.

Operation and detection

Operation and detection of the turnstile BT5 is via contacts, IP (optional) or RS485 network.

2 variants

The turnstile BT5 is available with a 90° spindle for increased safety and larger passage capacity, or with a 120° spindle for a more comfortable passage.

Standard version

The standard version is available in two colors; dark grey (RAL7016) and light grey (RAL9006), such as displayed on the preview.

Security level



Applications



Functionalities



Frame or spindle

The frame and spindle consist of painted aluminum profiles.

Mechanism

- the spindle revolves when pushed by a visitor
- the rotation of the column is controlled by a self-centering system which automatically places the column in the next starting position after every cycle. This avoids intermediate positions of the spindle.
- in case of power failure, a person will never be trapped inside the turnstile.

Intelligent control unit

- setup and configuration adjustable to the customer's needs
- display for diagnose
- various operating modes for each passage or direction: free access, controlled access (entrance or exit priority possible) and locked
- counting pulse for every movement
- compatible with any access control system
- easy control and diagnostic over IP (optional) or RS485 network

Variants

- spindle of 90° or 120°

Extensions

- integrated access control

Maximum throughput

- 30/min for free passage
- 17/min at proximity

Options

For more options: please consult our salesbook

Power supply	240 Vac
Nominal current	1,2 A
Operating temperature	-15°C to +45°C

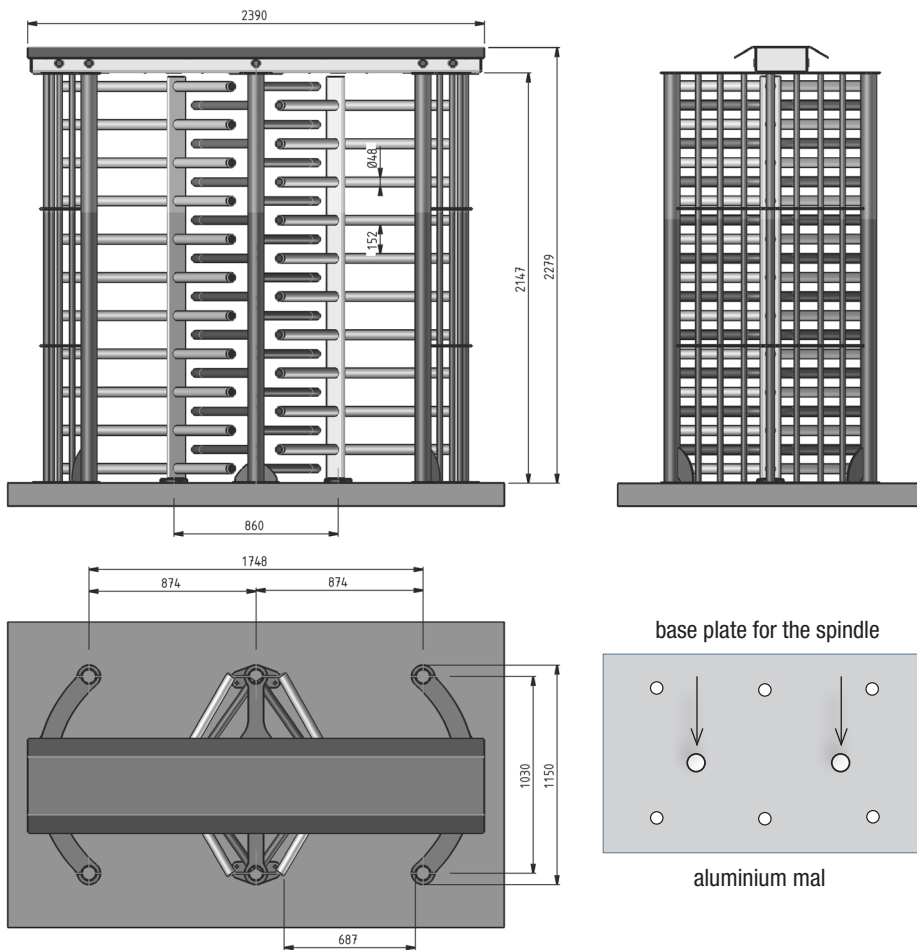



Barriers

Access control

Betafence barriers are part of our access control product range that works in perfect combination with our professional fencing systems.

Product detail

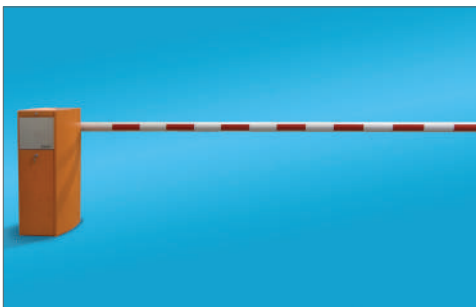

BENEFITS

Complete assortment

Both manual barriers (up to 8m) and automated barriers (up to 14m) are available as standard. Additional accessories such as under- and overclimb protection, traffic light, loop detector, LED signage, complete the range.

Reliability

The three-phase asynchronous motor and crank-connecting rod mechanism guarantee extremely reliable and maintenance-friendly operation. Via the electronic frequency control, a stepless and vibration-free movement is carried out - ensuring enhanced protection of the mechanism.

Access control

The electronic control can be programmed to suit any project or specific requirements of the customer. A widerange of options is available: induction loop detection, photo-cells, keyswitch, RF-remote control, card reader, key pad, coin receiver.

Quality

Steel housing, with polyester powder coated finish. Internal mechanical elements are electrogalvanised. Oval or round aluminium arm, white plastic coated with red reflexion strips and end-sealing. A simple configurable control with plenty of options.

Security level



Applications

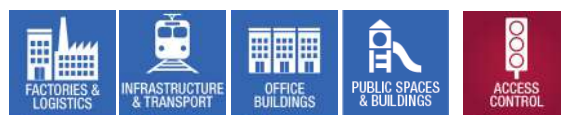









Functionalities

Manual barriers

Standard color: orange RAL 2000. All other RAL colors available on request.

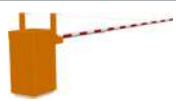
Type	230 Vac	
BL 10		- length: 3 - 4 - 5 - 6 - 7 - 8 m - round arm - option: with arm support

Automatic barriers

Type	230 Vac	
BL 15		- length: 2 - 4m / 0.5m - arm fixation: left or right - oval arm - for medium flow traffic
BL 229		- length: 3m - arm fixation: left or right - round arm - for medium-high flow
BL 40/41		- BL40 length: 3 - 8m / 0.5m - BL40 arm fixation: left or right - BL41 length: 6 - 12m / 0.5m - BL41 arm fixation: central - round arm - for medium and large passage width
BL 43/44		- BL43 length: 2 - 6m / 0.5m - BL44 length: 2 - 4m / 0.5m - arm fixation: central - reinforced oval arm - for medium - high security (BL44 very fast)
BL 46		- length: 3 - 7m / 0.5m - arm fixation: left, right - round arm - medium and wide passage
BL 52		- length: 6 - 14m - arm fixation: left, right or central - reinforced oval arm - for extra long passage width
BL 53		- length: 3 - 4 - 5 - 6 - 7 - 8 m - round arm - option: with arm support
BLG 76		- BLG76 L: 5,5m length by 1.7m height - BLG76 H: 5m length by 2,2m height (including barbed wire) - arm fixation: right or left - prevents vehicles and passengers
BLG 77		- BLG77 H: 5,080m length by 3,356m height - BLG77 M: 5,080m length by 2,137m height - BLG77 L: 6,350m length by 2,137m height - BLG77 HL: 6,350m length by 2,746m height - arm fixation: right - prevents vehicles and passengers

A wide variety of other barriers are available on request.

Colors

Standard color: orange RAL 2000.
All other RAL colors available on request
Standard: 230 Volts monophasic.

Options

Depending on the type, several options are possible, e.g.:

- radio-transmitter and -receiver
- key switch, card reader, push-button box, etc...
- inductive loop detectors
- signalization leds on arm
- tip support
- traffic sign
- rigid folding skirt
- folding tip support
- folding fence

Independent columns for access control

BOR 235:

The housing consists of sheet steel of a minimum thickness of 2 mm, rustproofed by electrogalvanising and a structured coat of epoxy paint (standard color: RAL 2000 orange). Total thickness of the protection exceeds 160 µm.

The single post height is such that the equipment is accessible to a passenger vehicle driver, while the double post is high enough for a heavy goods vehicle driver to reach.

1. Housing to be bolted to the ground (attachments not supplied), providing the space required to house the control equipment and any peripherals needed, connection terminals, etc.
2. Weather-sealed access door, lockable.
3. 6-mm demountable resin panel facilitating cut-outs and separating the metal part from the customer control equipment.
Color anthracite grey.
4. Canopy.

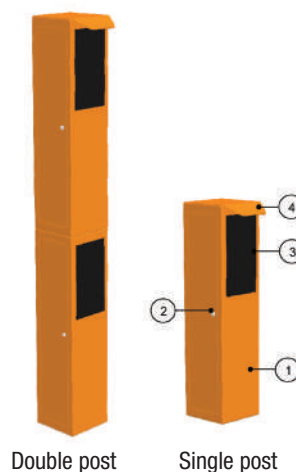

Double post

Single post



Round posts

Product detail



Wire holder have to be ordered separatly

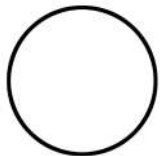

Compatible products

- Pantanet
- Fortinet
- Plasitor

Posts

Professional round metal posts, galvanised and plastic coated.

BENEFITS

- Standard system for welded fences and chainlink.

Description

Round tubular posts, posts with post length up to 3.25 m. On the upper position of the post, a hole is drilled to position your first wire holder. If you need additional ones, you are free to position your wire-holder (to be ordered separately) at the position which is the most suitable for your fence installation. Post supplied with a Betafence branded cap.

Coating technique

Galvanised in-and outside (275 g/m² - both sides combined) and plastic coated (min. 60 micron)



Colors

- Green RAL 6005. •** Green RAL 6005 & black RAL 9005 •* Green RAL 6005 & Antracite metallic BF7016M

ROUND POSTS (CORNER AND INTERMEDIATE POSTS)

Post diameter (mm)	Ø 38	Ø 48	Ø 48	Ø 60
Post length (mm)				
1000	•			
1200	•			
1500	•			
1750	•	•		
2000	•			
2100		•**		
2200				•**
2400			•**	
2500				•**
2600			•**	
2700				•**
3000			•**	
3250				•**

** also in black RAL 9005

ROUND POSTS WITH BENT ARM

Post diameter (mm)	Ø 48	Ø 60
Plate thickness (mm)	1,50	2,00
Post length (mm)		
3100	•	
3250		•

Bent arm length is 45 cm, bent under an angle at 40°, with 3 holes drilled every 49.5 cm for wire holders positioning. Also supplied with Betafence logo cap.

BRACE POSTS FOR BEKA CLIP AND ROUND POSTS

Post diameter (mm)	Ø 38	Ø 38
Plate thickness (mm)	1,25	1,50
Post length (mm)		
1500	•*	
1750	•*	
2000		•*
2200		•**
2500		•*
2700		•**
3000		•
3000		•
3500		
4000		
4750		

•* also available in Anthracite metallic BF7016M

•** also available in black RAL 9005
Brace posts are supplied with bolt for easy fixation to the intermediary and/or corner posts.



Bekacclip® posts

Product detail

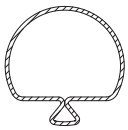
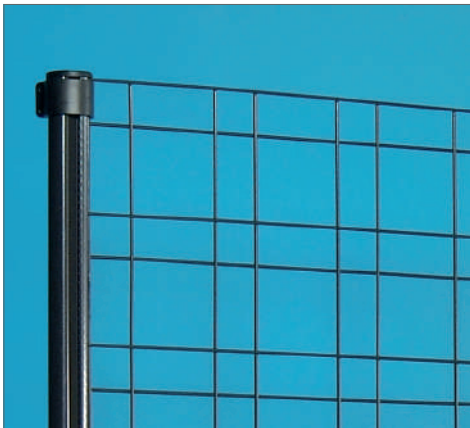

Compatible products

- Pantanet
- Fortinet
- Bekafor
- Zenturo Classic

Posts

Metal post with fixing strip for a fast and easy installation of fences on roll and residential panel fences.

BENEFITS

- Easy installation of welded fences and residential panels.

Description

Round post provided with mesh fixing strip and cap with Betafence branding.

Coating technique

Galvanised in-and outside (275 g/m2 - both sides combined) and plastic coated (min. 60 micron)



Accessories

- Stainless steel Bekacclip clips: Ø 3,50 mm for installation of fences on rolls
- Stainless steel Fortinet Super clips: Ø 3,50 mm for installation of Fortinet Super
- Bekacclip tongs for use with clips
- Collets Ø 48 mm and 60 mm for installation of panels Bekafor + Zenturo Classic
- Base plate available

Option

Post with cranked extension arm

Colors

Green RAL 6005

Metallic Anthracite BF 7016M

BEKACLIP POSTS

Diameter posts	Ø 48 mm	Ø 48 mm	Ø 60 mm
Thickness plate	1,20 mm	1,50 mm	2,00 mm
Post length (mm)			
700*	•		
1100	•		
1300	•		
1500	•		
1700	•		
2000	•		
2300		•	•
2500		•	•
2700		•	•
3000		•	•
3500			•
I/V (cm3)	1,90	2,38	4,98

Additional brace posts: see round posts
* Post to be put on floorplate

BEKACLIP POST WITH BENT ARM

Diameter posts	Ø 48 mm	Ø 60 mm
Post length (mm)		
3100	•	
3250		•
3600		•



HoriZen® system Basic posts

Posts

Aluminium extruded and polyester coated post without accessories. For easy installation of the HoriZen Composite & Aluminium boards.

Product detail

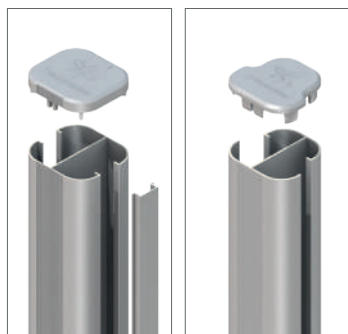

intermediate post

corner post



L-wall fixator

chemical anchoring set

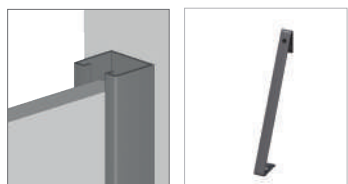

U-profile

wind anchor

Compatible products

- HoriZen composite & aluminium boards
- Decorative boards
- LED light bar

BENEFITS

- Light & elegant
- Polyester coated aluminum for long life time
- Very easy installation without accessories
- Can be installed in concrete or on base plate
- Corner post available
- Compatible with the decorative boards & LED light.

Description

- Post section 73 x 66 mm
- Plate thickness: 2,00 mm
- Every post is delivered with an aluminium finishing profile (to cover the post opening if used as start- or end post)
- Premounted plastic cap
- Corner posts are available for angles between 75° and 180°
- When a post for installation on a floor is ordered, the base plate is supplied automatically

Options

- L-wall fixator (for fixation of the fence on a narrow stone wall)
- Chemical anchoring set (for fixation of the base plate in concrete or stone)
- U-profile: for fixation of Composite & Aluminium boards directly to a wall to the gate posts or between existing posts
- Decorative boards & LED light
- Wind anchor (compulsory in wind-exposed situations)
- Adapter profile for vertical mounting of the boards

Colors

- Silver
- Anthracite

ASSORTMENT TABLE HORIZEN BASIC POSTS

for fence height mm	post length*		available post types	compatible infill
	in concrete mm	on base plate** mm		
<= 1000	1500	1050	straight line post corner post	Composite boards (Classic, XL, Platinum) Alu boards (Classic)
1000 - 1800	2400	1925		
> 1800 and slopes	2980			

* all posts can be cut to the required length if needed

** the posts for installation on floor or terrace automatically come with the base plate. No need to order separately.



HoriZen® system Clamp posts

Posts

Aluminium polyester coated post. For easy installation of the HoriZen Glass & Laminate panels (and/or in combination with Composite & Aluminium boards).

Product detail

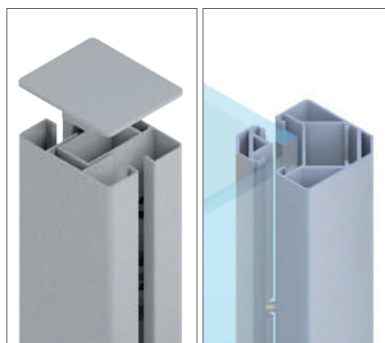

intermediate post

corner post



L-wall fixator

chemical anchoring set



wind anchor

base plate

elongation piece



cover plate, caps & base plates

Compatible products

- HoriZen Glass & Laminate panels
- HoriZen Composite & alu boards
- All combinations of panels & boards
- Decorative boards
- LED light bar

BENEFITS

- Universal post with variable spacing for different infills
- Polyester coated Aluminium for long life time
- Easy installation
- To be used for HoriZen panels (Glass or Laminate), and/or in combination with Composite & Aluminium boards
- Can be installed in concrete or on a floor or terrace (choose the appropriate accessory)
- Corner post available
- Stainless steel cover plate, cap & base plate available for a great finishing (optional)

Description

- Post section 77 x 74-84 mm (depth of the post depends on the HoriZen infill used)
- Plate thickness: 1,00 - 2,40 mm
- Every post is delivered with 2 Aluminium finishing profiles:
 - to cover the post opening if used as start- or end post
 - to anticipate the different thicknesses of the used infills
- 2 plastic caps with different size (to cover the min/max depth of the post)
- Corner posts for angles of 90°

Accessories

- Base plate for installation of the post on a concrete or stone floor or terrace
- Elongation piece for installation in concrete

Options

- L-wall fixator (for fixation of the fence on a narrow stone wall)
- Chemical anchoring set (for installation of the base plate in concrete or stone)
- Wind anchor (compulsory in wind-exposed situations)
- 1 set of stainless steel cover plate, caps & base plates
- Decorative panels & LED Light bar (only in combination with boards)

Colors

- Silver
- Anthracite

ASSORTMENT TABLE HORIZEN CLAMP POST

for fence height mm	post length		available post types	compatible infill
	in concrete mm	on base plate mm		
900 slanted panel sides height 900	1050 + elongation piece	1050 + base plate	straight line post corner post	Glass panels Laminate panels Composite boards (Classic, XL, Platinum) Alu boards (Classic)
1800	1925 + elongation piece	1925 + base plate		



Zenturo® posts

Posts

The unique Zenturo Post concept for decorative garden gabion walls.

Product detail

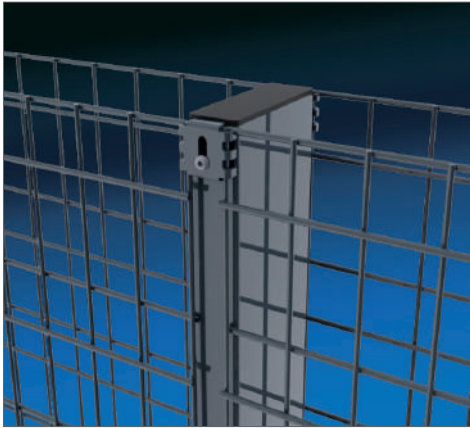

Compatible products

- Zenturo Classic
- Zenturo Super

BENEFITS

- **Aesthetically attractive and unique design with discreet fixators.**
- **The specific post profile offers optimal rigidity.**
- **High security factor: hexagonal safety bolt are used for the spider fixing.**
- **The wall withstands frontal wind loads of up to 120 km/h.**

Description

- Rectangular tube
- Section 120 x 40 mm, 2.00 mm
- IV: 17,34 cm³
- Inserts M6 at both sides

Accessories

- Metal spider fixators, hot dip galvanised and polyester plastic coated, are fixed to the post using stainless steel security hexagonal bolts M6 x 40 and stainless steel washers M6 (included in the packaging).
- Plastic post cap, pre-installed to the post.
- Specific Zenturo distance holders to prevent the panels from bulging under the weight of the wall infill. The use of distance holders is a must.

Coating technique

Internally and externally galvanised (275 g/m² both sides combined) and polyester plastic coated (min. 60 micron).



Colors

Metallic anthracite grey BF7016M

ZENTURO® POSTS			
Panel height mm	Post section mm	Post length mm	Spider fixators per post mm
655	120x40 x 2,00	1100	2 x 3
955	120x40 x 2,00	1500	2 x 4
1255	120x40 x 2,00	1700	2 x 5
1555	120x40 x 2,00	2000	2 x 6
1705	120x40 x 2,00	2400*	2 x 6 (*2 x 7)
2005	120x40 x 2,00	2700*	2 x 7 (*2 x 8)

* Extra inserts to mount 2 panels on top of each other

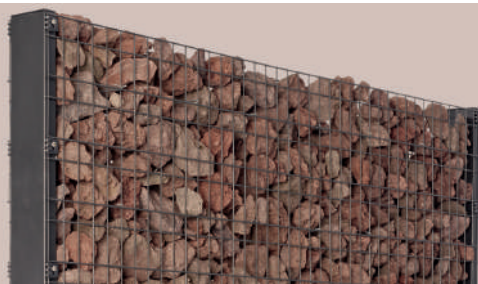

D-LOX[®] posts

Posts

Post system for flat panels.

Two fixing systems are available: with clamps or with U-covering plate

Product detail



BENEFITS

- 2 fixing systems available
- mounting support

Profile

- Welded rectangular posts
- Cross section of the post: 60 x 40 mm
- Plate thickness: 1.5 – 2 mm
- Hard plastic cap
- I/V: 5.00 cm³ (for plate thickness: 1.5 mm) or I/V: 6.19 cm³ (for plate thickness: 2.0 mm)
- Inserts in M8

Accessories

- Clamps
- U-covering plate
- 1 mounting support in steel on top of the post
- Base plate (welded)
- Security bolts M8 x 40
- Bent arms
- Corner clamps



Coating technique

Galvanised in-and outside (275 g/m² - both sides combined) and plastic coated (min. 60 micron)

Colors

D-LOX posts are standard available in galvanised execution, in green (RAL 6005) and metallic anthracite (BF7016M). Other RAL colors are available upon request.

Compatible products

- Nylofor 2D
- Nylofor F

D-LOX [®] POSTS			
Panel height mm	Post section mm	Post length mm	Number of clamps per post
630	60 x 40 x 1.5	1000	3
830	60 x 40 x 1.5	1300	3
1030	60 x 40 x 1.5	1500	4
1230	60 x 40 x 1.5	1700	4
1430	60 x 40 x 1.5	2000	4
1630	60 x 40 x 1.5	2200	5
1830	60 x 40 x 2	2400	5
2030	60 x 40 x 2	2600	5
2230	60 x 40 x 2	3200	6
2430	60 x 40 x 2	3000	6



E-LOX[®] posts

Posts

Posts for all Nylofor F and 3D panel-systems. A flexible post distance results in a simple and economical installation.

Product detail



Compatible products

- Nylofor 3D types
- Nylofor F

BENEFITS

- “Endless” installation
- Panels can be installed following the slope

Profile

- Welded rectangular posts
- Cross section of the post: 60 x 40 x 2.0 mm
- Hard plastic cap
- I/V: 6.19 cm³
- With pre-drilled holes for fixing the corresponding screw hooks in M8 with break-off nut

Accessories

- Base plate (separate or welded)
- Bent arms (single or double sided)
- Clips for 3D panels + plier
- Clips for F panels + plier

Coating technique

Galvanised in-and outside (275 g/m² - both sides combined) and plastic coated (min. 60 micron)



Colors

Standard available in galvanised execution, in green (RAL 6005), grey (RAL 7016). Other RAL colors are available upon request.

E-LOX[®] POSTS

Panel height mm	Post section mm	Post length mm	Number of hooks per post
630	60 x 40 x 2	1000	2
830	60 x 40 x 2	1300	2
1030	60 x 40 x 2	1500	3
1230	60 x 40 x 2	1700	3
1430/1530	60 x 40 x 2	2000	4
1630/1730	60 x 40 x 2	2200	4
1830	60 x 40 x 2	2400	4
2030	60 x 40 x 2	2600	5
2230	60 x 40 x 2	3000	6
2430	60 x 40 x 2	3200	6



O-LOX® posts

Posts

Rigid post system with cover plate or stainless steel fixing plate.
Variable fixing systems and post caps.

Product detail



with cover plate



with stainless steel fixing plate

Compatible products

- Nylofor 2D/2DS

BENEFITS

- 3 different fixing systems for 1 standard post
- Possibility to choose the post cap
- Steps of 200 mm

Profile

- Posts are foreseen of inserts every 200 - 400 mm
- PA clamps to support the panels are fixed to the posts with inserts M8
- Cross section post: 60 x 40 mm
- Plate thickness: 1.50 mm or 2 mm, depending on the height of the fence
- I/V 1.5 mm = 5.0 cm³
- I/V 2.0 mm = 6.19 cm³

Accessories

- Posts can be covered with post caps with or without overhang
- Flat steel cover plates (40x4mm)
- Stainless steel fixing plates of butterfly fixators
- Cover plate or fixing plates are bolted to the post with stainless steel bolts M8x40
- Corner clamps



Coating technique

Galvanised in-and outside (275 g/m² - both sides combined) and plastic coated (min. 60 micron)



Colors

Standard available in galvanised execution, in green (RAL 6005) and grey (RAL 7016).

Options

Posts can also be delivered with welded floorplates.

O-LOX® POSTS

Panel height mm	Post section mm	Post length mm	Inserts
630	60 x 40 x 1.5	1000	3
830	60 x 40 x 1.5	1300	4
1030	60 x 40 x 1.5	1500	4
1230	60 x 40 x 1.5	1700	5
1430	60 x 40 x 1.5	2000	5
1630	60 x 40 x 1.5	2200	6
1830	60 x 40 x 2	2400	6
2030	60 x 40 x 2	2600	7
2230	60 x 40 x 2	2800	7
2430	60 x 40 x 2	3000	8



O-LOX[®] Super posts

Posts

Rigid post system with cover plate or stainless steel fixing plate. Possible to combine with privacy strips.

Product detail

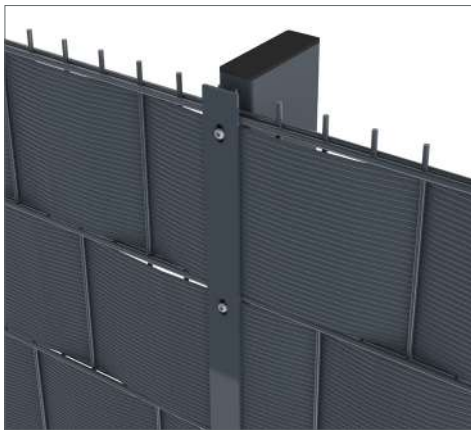

with stainless steel fixing plate

Compatible products

- Nylofor 2D/2DS
- Screno Wave

BENEFITS

- Strong and rigid post system for combination with privacy strips
- Post profile suitable for fence heights up to 4 m
- Steps of 200 mm are possible

Profile

- Posts are foreseen of inserts every 200 - 400 mm
- PA clamps to support the panels are fixed to the posts with inserts M8
- Cross section post: 120 x 40 mm
- Plate thickness: 2 mm, depending on the height of the fence
- $I/V = 17.34 \text{ cm}^3$

Accessories

- Posts are standard foreseen with a post cap
- Flat steel cover plates (40x4mm)
- Stainless steel fixing plates of butterfly fixators
- Cover plate or fixing plates are bolted to the post with stainless steel bolts M8x40
- Corner clamps



Coating technique

Zendzimir profiles and PES coating (min. 60 micron)



Colors

Standard available in galvanised execution, in green (RAL 6005) and grey (RAL 7016). Other colors are available on request.

Options

Posts can also be delivered with welded floorplates. Other heights are available on request.

O-LOX[®] SUPER POSTS - PANELS WITH PRIVACY INFILL (IN CONCRETE)

Panel height mm	Post section mm	Post length mm	Inserts
1830	120 x 40 x 2	2400	6
2030	120 x 40 x 2	2700	7

O-LOX[®] SUPER POSTS - PANELS WITH PRIVACY INFILL (ON FOOTPLATE)

Panel height mm	Post section mm	Post length mm	Inserts
1830	120 x 40 x 2	1884	6
2030	120 x 40 x 2	2084	7

O-LOX[®] SUPER POSTS - PANELS NOT FILLED

Panel height mm	Post section mm	Post length mm	Inserts
3060 (1030 + 2030)	120 x 40 x 2	3800	11
4060 (2030 + 2030)	120 x 40 x 2	4800	14





Izifix® posts

Posts

Profiled post, without fixators, compatible with 3D panel types. Easy and fast to install. Ideal for fence erectors looking for reliability and cost-efficiency.

Product detail

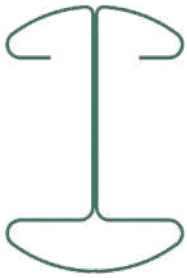

Compatible products

- Nylofor 3D
- Nylofor 3D Pro (XL)
- Nylofor 3D Essential
- Nylofor 3D Light
- Bekafor Classic

BENEFITS

- No fixators needed to maintain panels
- Long linguets for efficient stability of the panel into the post
- Angles up to 180° with the same post
- Slope installation with 100 mm steps
- No need to cut 3D profile to install the panel
- Cost-effective system

Profile

- Dimensions: 75 x 50 mm
- Slot every 100 mm
- Slope installation: 100 mm steps
- Yield strength: Min. 250 MPa
- Betafence branding on the front of the post
- Supplied with caps

Tools

- Tensioning tool to ensure a correct and easy installation

Options

- Base plate

Coating technique

Fully galvanised inside and outside. Finished with a polyester coating of min. 60 micron.



Colors

Green RAL 6005, white RAL 9010, black RAL 9005 and anthracite RAL 7016.
Other colors on request.

ASSORTMENT IZIFIX		
Post length in mm	Fence height in mm (on baseplate)	Fence height in mm (in concrete)
1075	1030	630
1275	1230	830
1475	-	1030
1575	1530	-
1775	1730	-
1975	1930	1530
2175	-	1730
2475	2430	1930
2575	-	2030

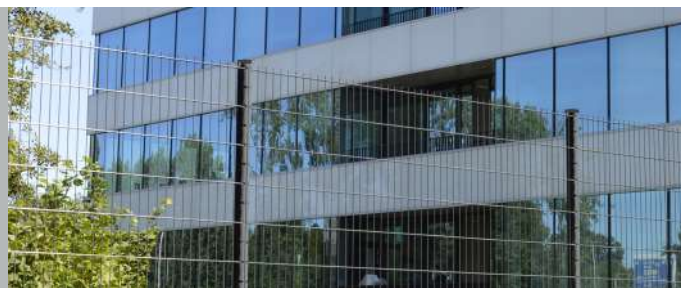

Rectangular post

Posts

The Type 4 post system is a cost efficient and flexible system. The posts are not pre-drilled, collars can be placed at any height.

Product detail



BENEFITS

- **cost efficient**
- **easy installation**
- **allows flexibility during installation : flexibility towards slopes**
- **free positioning of brackets**

Profile

- Post section: 60 x 40 x 1,5 - 2 mm (depending on post length)
- Post without inserts
- Standard black post cap in PA

Accessories

- Collets
- Collets advised every 400 - 600 mm
- Corner clamps



Colors

Standard available in galvanised execution and in RAL 6005 and RAL 7016

Compatible products

- All Nylofor panels

ASSORTMENT TYPE 4

Panel height mm	Post profile	Post length (in concrete) mm	Collets (advised)
1230	60 x 40 x 1.5	1700	4
1430/1530	60 x 40 x 1.5	2000	4
1730/1830	60 x 40 x 1.5-2	2400	5
1930/2030	60 x 40 x 1.5-2	2600	5



Bekafix® posts

Product detail

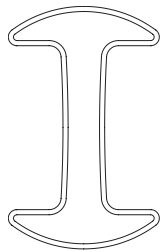

Compatible products

- All Nylofor panels
- CreaZen
- Decofor

Posts

Profiled posts, polyester coated or galvanised with fixing system to be used with multiple panels.

BENEFITS

- Very attractive symmetrical shape, patent protected
- Fixing system almost not visible
- Steps for slopes: 2,5 cm
- Ideal for all panels in medium security
- Perfect for installation with concrete plate

Profile

- Tubular post, profiled in "H" shape, plate thickness: 1,25 mm
- With 3 pre-drilled holes for fixing of the special metal security clips with bolts
- With punched holes for positioning and fixing of the panels by means of fixing clips
- Cross section of the post: 70 x 44 mm
- **II/V: 5.28 cm³ | Yield strength: 250 MPa | Relative strength: 132**
- Cap with hook to support panels during installation

Accessories

- Security fixation system: plastic coated metal clip with as an option stainless bolt with nut with break-off head
- Metal or polyamide fixing brackets
- Bekafix installation tongs
- Floor plate
- Connection piece to create bent arm for panels or extension
- Single or double bent arms

Coating technique

Galvanised: inside and outside and polyester coated (minimum 60 microns).



Colors

Green RAL 6005 and grey RAL 7016 Other colors are available on request.

ASSORTMENT BEKAFIX® POSTS

Panel height mm	Post length mm		Number of fixators/post (intermediate/corner post*)
	Concrete	Baseplate	
630	1075	675	2 x 2
830	1275	-	2 x 2
1030	1475	1075	2 x 2
1230	1675	1275	2 x 3
1430	1975	-	2 x 3
1530	1975	1575	2 x 3
1630	2175	1675	2 x 3
1730	2175	1775	2 x 3
1830	2475	1875	2 x 4
1930	2475	1975	2 x 4
2030	2575	2075	2 x 4
2230	2775	-	2 x 4
2430	3175	2475	2 x 4

* end post = only half of the numbers of fixators necessary



Bekafix® Ultra posts

Product detail

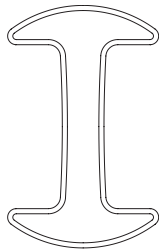

Compatible products

- All Nylofor panels (in superposition) up to 4 m
- CreaZen panels
- Securifor panels up to 3 m

Posts

A higher rigidity profiled post, for medium to high security applications, at an excellent price-quality ratio.

BENEFITS

With the Bekafix Ultra post, all the benefits of the standard Bekafix post are kept, but by increasing the inertia considerably, its application range has become much wider.

- Quick installation
- Concrete plates maintained directly in between the posts, without any plate holders
- Same accessories as the standard Bekafix posts
- 10 Years guaranty in Extreme conditions

Profile

- Tubular post, profiled in "H" shape, cross section of the post: 70 x 44 mm, plate thickness: 1.75 mm
- With central holes every 15 cm, for fixing of the special metal security clips with bolts
- With side punched holes for positioning and fixing of the panels by means of fixing clips
- **I/V:** 7.29 cm³ | **Yield strength:** 550 MPa | **Relative strength:** 401
- Post cap with hook to hang panels for ease of installation.

Accessories (same as Bekafix Standard post)

- Fixing system: plastic coated metal clip with, as an option, one-way security bolt or PA standard clips.
- Bekafix installation plier
- Spider fixing for installation of Securifor panels
- Base plate for installation on tiles or concrete floor
- Connection piece to create bent arm for panels or extension
- Single or double bent arms for Bekafix range

Coating technique

Magnelis®: inside and outside and polyester coated (minimum 100 microns).

Colors

Green RAL 6005, Black RAL 9005, Anthracite RAL 7016 and White RAL 9010
Other colors are available on request.



BEKAFIX® ULTRA POSTS

Fence height mm	Post length mm	Number of fixators per intermediate post	Number of fixators per end post
1930*	2475	8	4
2030	2575	8	4
2430	3175	8	4
3000	3775	10	5
4000	4775	12	6

* The same post can be used for installation in concrete or footplate

Other heights available on request



Nylofor® square post

Posts

Square posts, polyester coated on galvanised with a special fixing system. To be used with all Nylofor panels.

Product detail



BENEFITS

- Universal post designed to fit all our low to medium security panels
- Classic square design
- Options for metal or nylon fixings. A clamp bar solution is also available for certain panel types.
- Posts include stepping holes for installations on sloped ground. Extra holes provide 100mm option

Profile

- Tubular post with square cross section 60 x 60 x 1,5 mm
- With inserts and fixators for the assembly of panels
- Standard plastic post cap with the Betafence logo
- Available post on welded base plate
- I/V: 6,68 cm³

Options

- Bolt-able base plate
- Concrete plate holder
- Cranked extension arm + connection piece
- Security profile for NYLOFOR F / 2D / 2DS
- Corner clamps

Accessories

- Fixators nylon and metal
- Stainless steel bolts
- Clamp bar

Coating technique

Galvanised: inside and outside and polyester coated: minimum 60 microns

Colors

Post are available as standard in green RAL 6005, black RAL 9005, white RAL 9010, anthracite RAL 7016 and other color are available on request.

Compatible products

- All Nylofor panels
- Roll top panel
- Paladin panel

Nylofor square post				
Height of fence (mm)	Post for concrete height (mm)	Post with base plate height (mm)	Number of fixators per intermediate and end post	Number of fixators per corner post
630	1000	674	3	6
1030	1500	1074	3	6
1230	1800	1274	4	8
1430	2100	1474	4	8
1530	2100	1574	4	8
1630	2400	1674	5	10
1730	2400	1774	5	10
1830	2500	1874	5	10
1930	2500	1974	5	10
2030	2700	2074	6	12
2230	-	2274	6	12
2430	3100/3400	2474	7	14

Twilfix square post

Posts

Square posts, polyester coated on galvanised with a special fixing system. To be used with all Nylofor panels.

Product detail



BENEFITS

- Universal post designed to fit all our low to medium security panels
- Classic square design
- Options for metal or nylon fixings. A clamp bar solution is also available for certain panel types.
- Posts include stepping holes for installations on sloped ground. Extra holes provide 100mm option

Profile

- Tubular post with square cross section 60 x 60 x 1,5 mm
- With inserts and fixators for the assembly of panels
- Standard plastic post cap with the Betafence logo
- Available post on welded base plate
- I/V: 6,68 cm³

Options

- Bolt-able base plate
- Concrete plate holder
- Cranked extension arm + connection piece
- Security profile for NYLOFOR F / 2D / 2DS
- Corner clamps

Accessories

- Fixators nylon and metal
- Stainless steel bolts
- Clamp bar

Coating technique

Galvanised: inside and outside and polyester coated: minimum 60 microns

Colors

Post are available as standard in green RAL 6005, black RAL 9005, white RAL 9010, anthracite RAL 7016 and other color are available on request.

Compatible products

- All Nylofor panels
- Roll top panel
- Paladin panel

Twilfix square post				
Height of fence (mm)	Post for concrete height (mm)	Post with base plate height (mm)	Number of fixators per intermediate and end post	Number of fixators per corner post
630	1000	674	3	6
900	1500	1074	3	6
1030	1500	1074	3	6
1230	1800	1274	4	8
1430	2100	1474	4	8
1530	2100	1574	4	8
1630	2400	1674	5	10
1730	2400	1774	5	10
1830	2500	1874	5	10
1930	2500	1974	5	10
2030	2700	2074	6	12
2230	-	2274	6	12
2430	3100/3400	2474	7	14

Bekasport system

Posts

With its noise reducing qualities, it is the ideal system for fencing and protecting sport areas.

Product detail

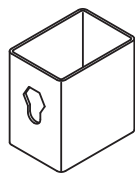

- Our noise clamping clips limit the sound generated by a ball striking the fence.
- The Bekasport system has an official certificate that proves its noise reducing capabilities. (this certificate is available on request)

Compatible products

- Nylofor 2DS

BENEFITS

- The Bekasport post system is available for sports applications in heights up to 6 m.
- The use of Nylofor 2D Super panels makes the whole system extremely rigid.
- Panels with a mesh size of 200 x 50 & 200 x 100 mm are combined

Profile

- Rectangular steel posts
- Equipped with keyhole-shaped slots for fixing the panels by means of special fixing clamps
- Black plastic post cap
- Cross section of the post: 80 x 50 mm, 100 x 50 mm, 120 x 50 mm, depending on the post lengths.
- I/V: see the table below

Accessories

- Special fixators to form corners of 90° (left & right)
- Fixing sets including:
 - plastic fixator +nut (pre-assembled)
 - metal cover plate PES coated in RAL 9005
 - bolt 8x45

Coating technique

Panels are made out of galvanised wires. An adhesion coating is given for a perfect adhesion with the polyester coating (min. 100 micron). Posts are hot dip galvanised and plastic coated. (min. 60 micron)



Colors

All Bekasport posts are made on request. Contact us for more info.

BEKASPORT POSTS

Height fence mm	Dimensions Nylofor 2D Super panels width x height mm			Dimensions post mm		
	Mesh 200 x 50 mm width x height mm	Mesh 200 x 100 mm width x height mm	Number of fixators per post	Post length mm	Profile post mm	I/V cm3
3000	2500 x 2030	+ 2500 x 1030	10	3800	80 x 50 x 3,0	15,29
4000	2500 x 2030	+ 2500 x 2030	12	4800	80 x 50 x 3,0	15,29
5000	2500 x 2030	+ 2500 x 2030 + 1030	16	6000	100 x 50 x 3,0	21,29
6000	2500 x 2030	+ 2500 x 2030 (2x)	18	7000	120 x 50 x 4,0	35,64





Securifor® rectangular posts

Product detail

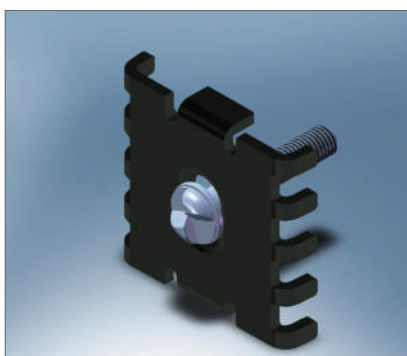
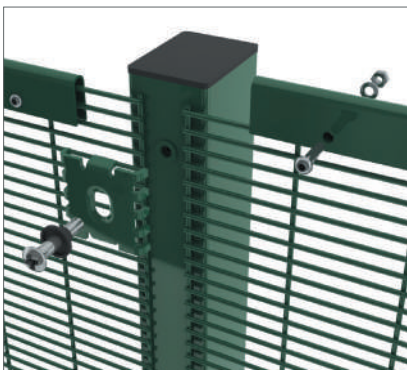

Posts

Rectangular posts, polyester coated on galvanised plate with special fixing system.

BENEFITS

- Frontal fixation of Securifor panels on Securifor square posts by means of special fixing brackets or clamp bars.

Profile

- Posts made of galvanised steel profiles
- Intermediate & end posts: 80 x 60 x 2,5 mm or 120 x 60 x 3,0 mm with inserts for frontal fixation of panels.
- Corner posts: 80 x 60 x 2,5 mm or 120 x 60 x 3 mm with one insert on two adjacent sides to insert two panels in an angle.
- I/V : 15,1 cm³ (80 x 60 x 2,5 mm)
- I/V : 31,98 cm³ (120 x 60 x 3 mm)

Accessories

- Brackets
- Stainless steel one-way bolts M8
- Cover plates

Options

- Posts with base plate
- Vertical extensions arms to support 3 rows of barbed wire available to provide additional security.

Coating technique

Galvanised (min. 275 g/m²) & polyester coated (min. 60 microns)



Colors

Green RAL 6005.

Other colors are available on request.

ASSORTMENT RECTANGULAR SECURIFOR® POSTS

Panel height mm	Profile post mm	Post length mm
2010,6	80 x 60 x 2,50	2600
2417,0	80 x 60 x 2,50	3100
3001,2	80 x 60 x 2,50	3700
4004,5	120 x 60 x 3,00	4800

Compatible products

- Securifor
- Securifor 2D
- Securifor 3D
- Securifor 4D

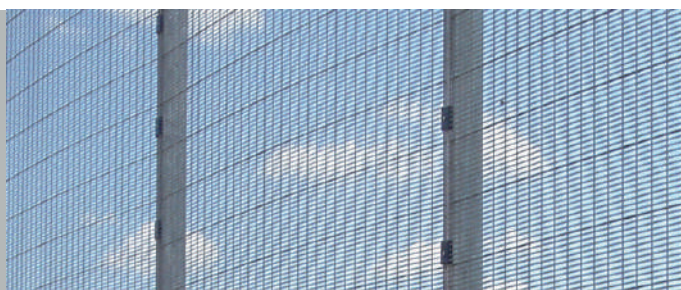

Bekasecure® posts

Posts

The Bekasecure posts have a unique design and guarantee higher security, important rigidity and easy installation.

Product detail

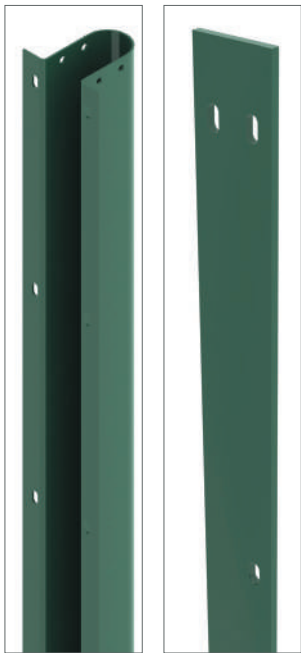

BENEFITS

Bekasecure post system with cover plate

The Bekasecure posts have a unique patented profile and are available with or without base plate. The panels are secured by using a continuous cover plate and specific stainless steel security bolts.

- **The post's design and high yield strength steel provides the ultimate in high security, rigidity and ease of installation. The open profile of the post allows for electrical or fibre optic cabling.**
- **Patented system**

Profile

- Post profile "Omega", 140 x 135 x 4,00 mm (up to 6m fence height)
- With a double range of holes 10 x 20 mm for the fixation of panels and cover plates.
- Specific metal cap
- I/V: 43,6 cm³

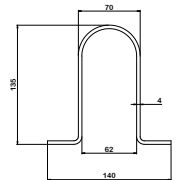

Accessories

- Cover plate
- One-way security bolts (for the fixation of panels, cover plate and metal caps).
- Metal caps

Options

- Bent arms
- Base plates
- Cover plates for corners

Coating technique

Profiles are hot dip galvanized.
Polyester coated (min. 60 microns)



Colors

Green RAL 6005
Other colors: on request

Compatible products

- Securifor flat
- Securifor 2D/4D

BEKASECURE POSTS			
Panel height mm	Post length mm	Base plate mm	Cover plate (length) mm
Bekasecure posts – to put in concrete			
	4050	-	3050
3001,2	4800	-	2060+1730
3674,3	4800	-	2060+2060
4004,5	4800	-	2060+2060
Bekasecure posts – with base plate			
4004,5	4050	230 x 230 x 15	2060+2060
6011,1	6030	300 x 300 x 20	2060+2060+2060

* cfr. installation guide: available on request





Tempofor®

Mobile Fences

Fencing systems for temporary protection and control of people, vehicles and goods.

Product detail



BENEFITS

Quality and durability

The panels are made out of pre-galvanised or HDG materials for a long-lasting corrosion protection in all weather conditions. Each wire is individually welded to the frame.

Flexibility

A wide assortment of panels and accessories provides a solution for any temporary security need. Different connection systems and logistic possibilities offer flexibility in transport and installation.

Service

An extended network of suppliers guarantees a qualitative and fast delivery, for both purchase and rental of construction barriers.

Security level



Applications



Functionalities



Tempofor F range

- F1:** standard mobile fence panel of 1,2 meter height
- F2:** standard mobile fence panel of 2 meter height
- F2 Medium:** light mobile fence panel
- F2 Supermedium:** standard mobile fence panel with extra light tubes and wires
- F2 Super:** mobile fence with reinforced horizontal and vertical tubes and mesh, ideal for heavy duty usage, e.g. for rental.
- F2 Protect:** HDG standard mobile fence of 2 meter high with reinforced corners
- F2 Secure:** anticlimb mobile fence panel with small mesh size
- F3:** standard mobile fence panel with extra horizontal tube for more rigidity
- F3 Maxi:** mobile fence panel of 2,45 m height with extra horizontal tube and smaller mesh size



Tempofor F2

Tempofor B range

Creating privacy for construction sites or events. Heavy duty, hot-dipped galvanised steel frame with profiled & coated steel plate infill. Available in several color combinations (white, blue, yellow), other colors on request. Compatible with standard mobile fence panels and accessories. Use of braces obligatory.

- B1:** Standard panel of 1,2 m height
- B2:** Standard panel of 2,0 m height
- B3:** Semi-closed version of 2,0 m height

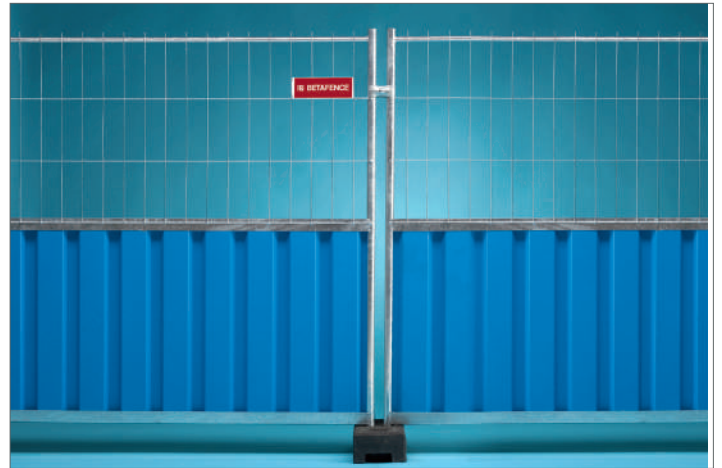

Tempofor B3

Tempofor C range

- C1:** Guiding panel with reinforced upper guiding rail for crowd control.
- C2:** standard crowd barrier
- C2 Light:** light crowd barrier
- C2 Eventsecure:** Inclined crowd barrier (3m), for extra safety of spectators during cycling events.
- CycloSecure:** Inclination crowd barrier (3m), especially designed for extra safety of both spectators and bikers during cycling or other events.
- C3:** police barrier, maximum stability for controlling big crowds, foldable C3 is also available in a foldable version.
- C6:** Mobile crowd guidance system: for effective entry control to events.



Tempofor F2 Protect

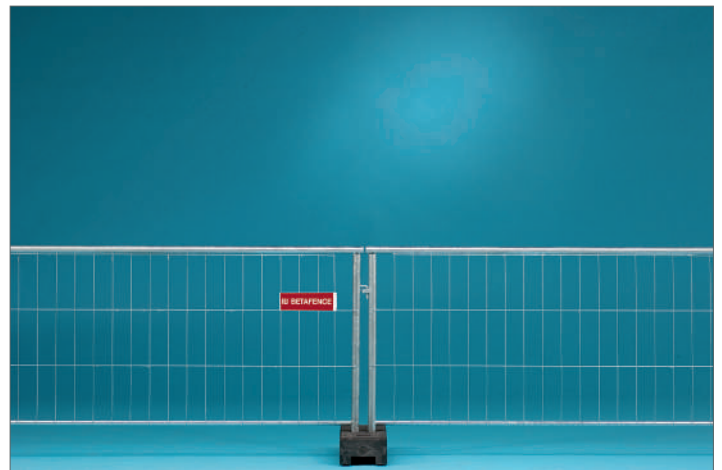

Tempofor C1

Eventsecure



B2



C2: Crowd entrance system



TEMPOFOR F-RANGE

Type	Description	Dimensions width x height	Mesh size width x height	Wire dia. hor.	Wire dia. vert.	Tube dia. hor.	Tube dia. vert.	Weight kg
F1	standard panel	3454* x 1200	100 x 300	3	3	27	40	10,5
F1	infill panel	2200 x 1200	100 x 300	3	3	27	40	8
F1	gate	1200 x 1200	100 x 300	3	3	27	40	6,5
F2	standard panel	3454* x 2000	100 x 300	3,8	3,4	27	40	16
F2	infill panel	2200 x 2000	100 x 300	3,8	3,4	27	40	11,5
F2	gate	1200 x 2000	100 x 300	3,8	3,4	27	40	7
F2 Medium	standard panel	3454* x 2000	100 x 300	3	2,5	27	40	13
F2 Supermedium	standard panel	3454* x 2000	100 x 300	2,5	2,5	27	40	11,5
F2 Protect	standard panel	3454* x 2000	100 x 300	3	3	27	40	15
F2 Super	standard panel	3454* x 2000	100 x 300	4,5	4	38	40	20
F2 Secure	anticlimb panel	3454* x 2000	30 x 160	3,8	3	27	40	25
F3	standard panel	3454* x 2000	100 x 300	3,4	3	27	40	17
F3	infill panel	2200 x 2000	100 x 300	3,4	3	27	40	12
F3	gate	1200 x 2000	100 x 300	3,4	3	27	40	8,5
F3 Maxi	extra high panel	3454* x 2450	50 x 291	4	4	27	41	33

TEMPOFOR B-RANGE

Type	Description	Dimensions width x height mm	Profiles horizontal top	Profiles horizontal bottom	Tube dia. vert.	Weight kg
B1	standard panel	2200 x 1200	60 x 40 x 1,5 (U)	60 x 35 x 1,5 (2xL)	41	22
B2	standard panel	2200 x 2000	60 x 40 x 1,5 (2xL)	60 x 35 x 1,5 (U)	41	30
B3	semi-closed panel	2200 x 2000	60 x 40 x 1,5 (U)	60 x 35 x 1,5 (2xL)	41	31

TEMPOFOR C-RANGE

Type	Description	Dimensions width x height	Mesh size width x height	Wire dia. hor.	Wire dia. vert.	Tube dia. hor.	Tube dia. vert.	Weight kg
C1	crowd barrier	3454* x 1200	100 x 300	4,5	3,8	41	41	17
C2	crowd barrier	2500 x 1100	-	tubes dia 16	-	38	38	19
C2 Light	crowd barrier	2500 x 1100	-	tubes dia 13	-	25	25	16
C2 Eventsecure	crowd barrier	2200 x 1000	-	tubes dia 16	-	38	38	22-26 kg
C2 CycloSecure	crowd barrier	3000 x 1000	-	tubes dia 16	-	38	38	36,5
C3 Hingeable	police barrier	2170 x 1100	-	-	-	34	34	57
C3	police barrier	2070 x 1200	-	tubes dia 20	-	38,5	38,5	39

* distance between centre of bases = 3500 mm

C2



Connection systems

- adjustable brackets with nut and bolt
- wire loops for quick installation
- hook/eye connection
- security connectors for a durable and secure connection



Accessories



Concrete block



Concrete block light



PE block 16kg



PE block 22kg



PVC block



Pedestal



Steel plate



Mobile plate



Ground anchor/cone



Triangular brace post



Hinge set



Ring

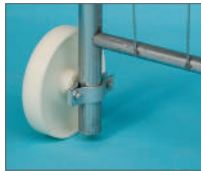

Wheel



Stol-connector



Customer name plate



Security connector (+tool)

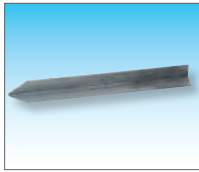

Ground pin



Anti-lift device



Barbed wire holder



Barbed wire holder Y



Brace



Curtain 3,5 m / 20 m - blue/black/white

Logistics



System KP30
for F-panels and blocks



TP 25 / TP 29

Turnstiles



Tempofor Turnstile

The Tempofor BF3 Turnstile is designed and built to control and secure access to construction sites, temporary facilities and events.

CycloSecure





Publifor®

Security Barriers

Publifor® system consists of a concrete base encased in steel, surpassed by a frame. This frame is filled with panels according to the specific application.

Product detail



BENEFITS

Fast installation

No physical anchoring in the ground is needed. The units are set down where needed with a forklift truck and then connected together.

Different levels of security

Different panel types can be mounted in the frame.

Modular

Different panels are possible. Gates are available with fast unlock if necessary. Accessories available for increased security.

Easy to move

The concrete base weighs more than 2 tons but notches have been provided in the concrete base for a forklift truck for easy handling.



Security level



Applications



Functionalities



System Base



Base with standard dimensions L 2550 x W 700 x H 805 mm.
Metal sheet: 2 mm.
To be filled with concrete.

Frame



On top of the system base a rectangular frame is welded: 80 x 60 mm (heavy version) or 60 x 60 (light version).
Metal plates are foreseen on both sides to connect the different units.

Panels



Panels are fixed a single side or on both sides of the frame with fixators: Nylofor 2DS, Nylofor 2D, Nylofor 3D, Securifor and Securifor double skin. Those panels can be combined with closed infills: Nylofor 2DS panels or Securifor panels + metal sheet.



Special polycarbonate version for transparency and high resistance to load, to impact, to graffiti and fire.

Options

- Bent arms: single and double versions available
- Defensive spikes
- Closed infill: metal sheet pre-installed
- Customised solutions or request

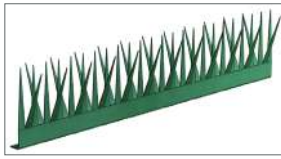

Gates



Gates are installed directly on the Publifor modules.
The opening systems guarantees 180° and a fast unlock for emergency situations. Single and double swing gates certified until free passage till 628 cm (2 x 314).

Corners

Corners till 90° can be easily installed by means of special corner modules.

Coating technique

The panels are made of galvanised wire, and an adhesion layer is provided for perfect adhesion with the polyester top coat (min. 100 micron). The posts are internally and externally galvanised (min. layer thickness 275g/m², both sides combined) according to Euro standard EN 10346, after which an adhesion layer is applied and polyester plastic coated (min. 60 micron);

Colors

Panel color: standard green RAL 6005
Base color: standard grey RAL 7046
Gate color: standard yellow RAL 1012

ASSORTMENT PUBLIFOR SUPER

Type 4000	Dimensions		HEAVY version		LIGHT version		HEAVY profile	LIGHT profile
	Base L x W x H	Total module L x W x H	Nylofor 2D Super	Securifor	Nylofor 3D	Nylofor 2D	Horizontal frame	Vertical frame
Mid-panel	1230 x 700 x 805	1230 x 700 x 2500	x	x	x	x	80 x 60	60 x 60
Mid-panel	2530 x 700 x 805	2530 x 700 x 2500	x	x	x	x	80 x 60	60 x 60
Corner panel	1230 x 700 x 805	1230 x 700 x 2500	x	x	x	x	80 x 60	60 x 60
Corner panel	2530 x 700 x 805	2530 x 700 x 2500	x	x	x	x	80 x 60	60 x 60





SmartFence®

Smart Conduit System

Efficient and cost-effective solution for housing security system cables.

Product detail

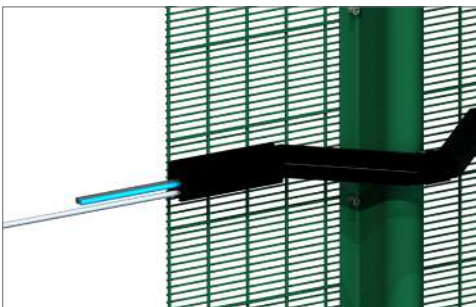

BENEFITS

SmartFence is designed to house power, data, and detection cables in one easily accessible conduit. The fence-mounted system is a cost-effective solution that reduces civil works, simplifies installation, retrofitting, and integration. Durable steel and aluminium protect cables against tampering and the elements. Tests show that detection accuracy and functionality remain unaffected with no increase in nuisance alarms.

- Reduced civil works requirement
- Cost-effective laying of integrated security system cables
- Single conduit housing power, data, and detection
- Power cable in a separate chamber
- Quick and easy installation and retrofitting
- Continuous and stable cable protection
- 10-Year Guarantee

Security level



Applications

 DATA CENTERS	 ENERGY & RESOURCES	 MILITARY BASES	 OIL & GAS	 DISSUASION	 DESIGN	 DETECTION
---	---	---	---	---	---	--

Functionalities

Features

Underground ducts and drawing of cables through conduits and posts is not necessary with SmartFence. All cables required for an integrated security system can be mounted on the fence. A removable cover allows for easy laying, adding, and replacement of cables. This significantly reduces installation and maintenance costs.

- 1 SmartFence conduit cover
- 2 Detection cable
- 3 Data cable
- 4 Power cable in a separate chamber within conduit

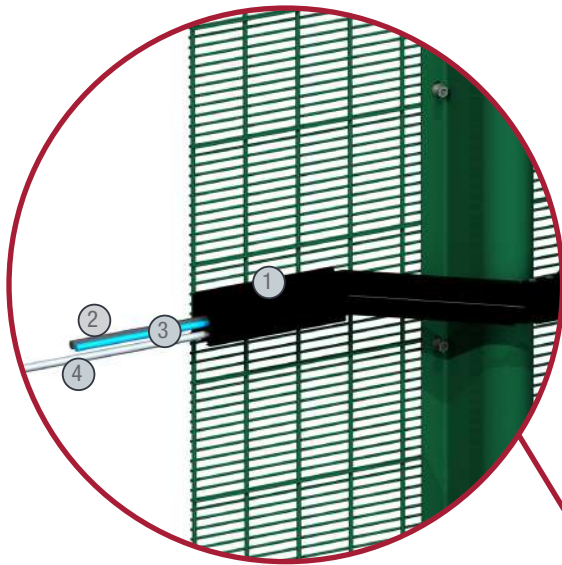

Compatibility

Fence panels	Posts
<ul style="list-style-type: none">• Securifor®• Nylofor®	<ul style="list-style-type: none">• Bekafix®• Bekafix® Ultra• Bekasecure®• Nylofor® Twilfix• LOX posts• Rectangular SEC posts

Ease and Flexibility

SmartFence allows for easy stepping and sloping, adapts to any type of corner, and can be installed anywhere on the fence. It is easy to mount and fix to the panel without the need for specialized tools. Two mounting bracket sizes are available to fit different posts.

Coating Techniques and Colours



SmartFence is PES coated in black RAL 9005. Other colours available on request, minimum order quantities apply.

10-Year Guarantee



SmartFence is covered by Betafence's 10-Year Guarantee. Visit our website for full terms and conditions.

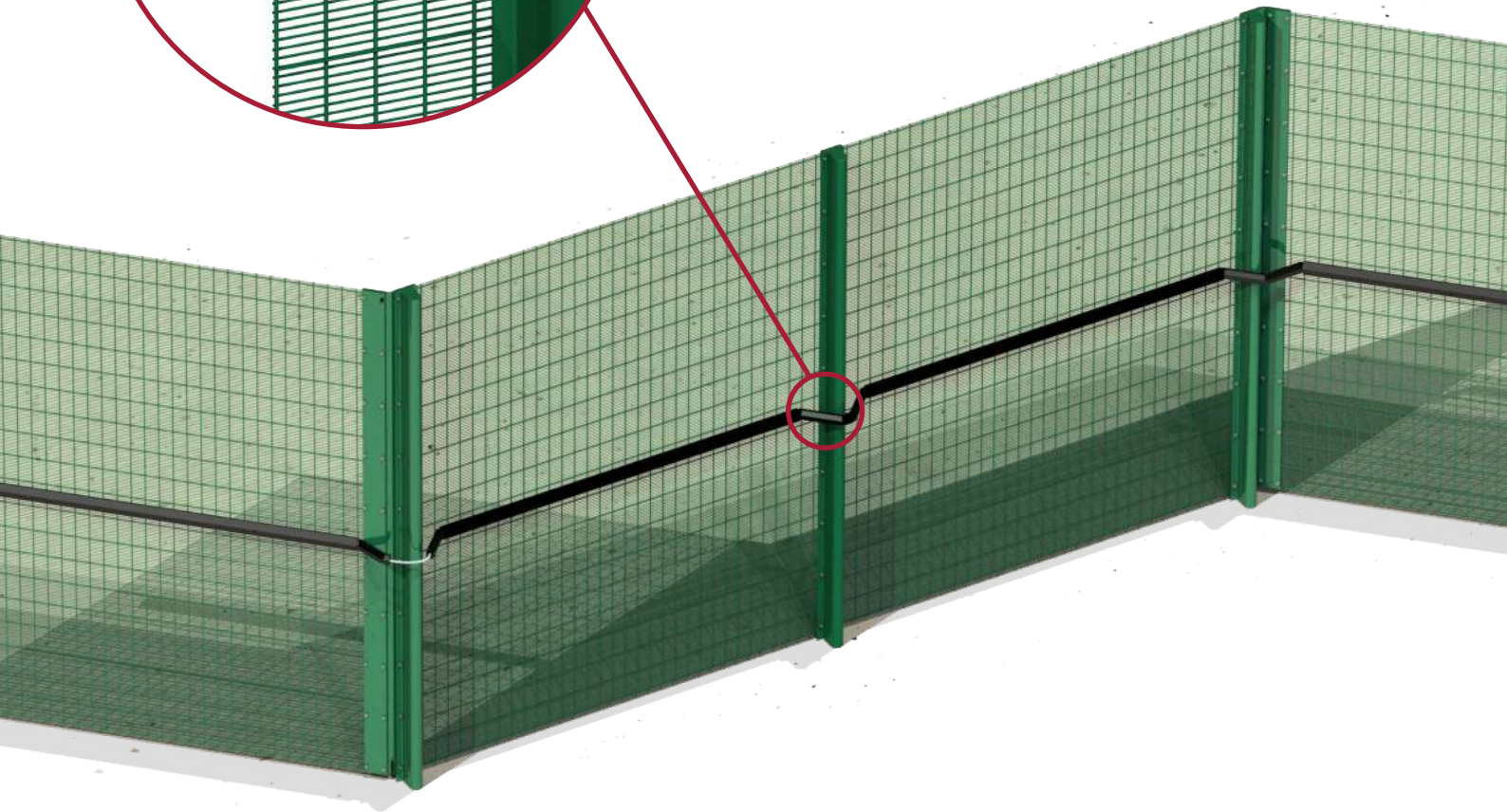

Specials

Barbed wire with alternately twisted wires.

Product detail

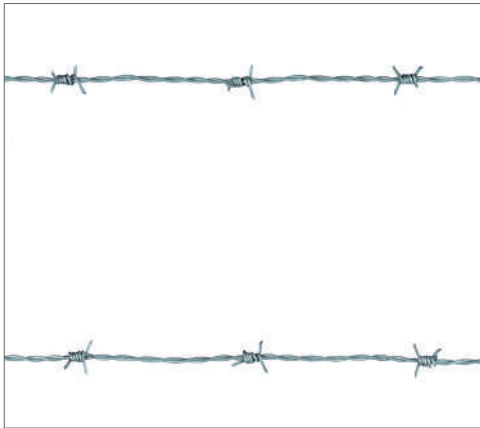

The 2 running wires are alternately twisted between the 4-point barbs.

Wire

The high-carbon steel wires are every 10 cm provided with 4-point barbs.

Zincalu:

- tensile strength of the line wires : min. 1150 N/mm² (before stranding)
- tensile strength of the barb wire: 700/900 N/mm²
- breaking load of the strand wire: min. 4230 N

Wire diameter

Zincalu:

- line wire: 1,70 mm
- barb wire: 1,45 mm

Applications



Functionalities



Coating

Zincalu coating

Assortment

Motto Zincalu:

Length of the rolls: 50-100-250-500 m



Razor Tape

Specials

The razor wire coils are manufactured using mild steel wire and are equipped with sharp blades. It adds an anti-climb quality to almost all fences.

Product detail

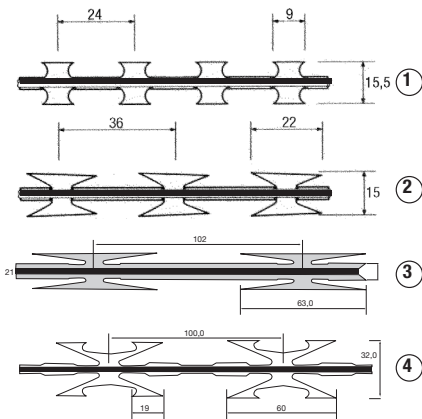
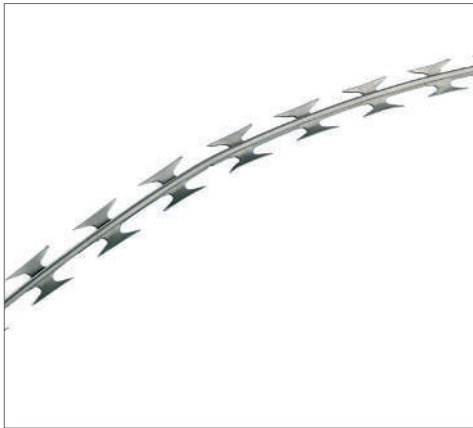

BENEFITS

- The barbed wire systems “Razor Tape” are an effective deterrent to climbing the fence, they provide maximum delay and limit break-ins.
- The state of the art coating technology guarantees a long product lifetime.
- All accessories are precisely integrated for quick and easy installation.
- A large variety of products is available on demand (a.o. different coil diameters) providing different levels of security.

Systems

The Standard Razor Tape product of Betafence has a wire diameter of 2.5 mm and consists of a continuous mild steel strip that is enclosed with sharp blades. All coils are clipped together to obtain a stable and homogeneous network.



Flat concertina: This is a network of spirals that are clipped and has a flat overlap.

The razor wire is a single ribbon of barbed wire with sharp blades that are unclipped and stretched above the fence.

Coating

		Blades		
		Heavy galvanised	Galvanised	Stainless steel
Core wires	Heavy galvanised	x	x	x
	Galvanised		x	
	Stainless steel			x

Accessories

Clips Gloves Pliers Ground hooks

Barbed Wire Profiles

- | | | | |
|----------------------|---|--------------------|---|
| ① Short Barb | Length of Barbs: 9 mm
Width of tape: 15,5 mm | ③ Long Barb | Length of Barbs: 63 mm
Width of Barbs: 21 mm |
| ② Medium Barb | Length of Barbs: 22 mm
Width of tape: 15 mm | ④ Detainer | Length of Barbs: 60 mm
Width of Barbs: 32 mm |

Applications



Functionalities



ASSORTMENT RAZOR TAPES - STANDARD TYPES

	Approximate diameter of the compact coil	Spirals per coil	Length m	Clips per spiral	Approximate diameter of the stretched coil mm
Medium BARB galvanised/heavy galvanised blades	730	56	12	5	610
Detainer heavy galvanised / heavy galvanised blades	730	51	10	5	630

All other combinations on request



Specials

High value added welded mesh, galvanised or galvanised and plastic coated, used for professional applications as well as in the garden or for small animals.

Product detail

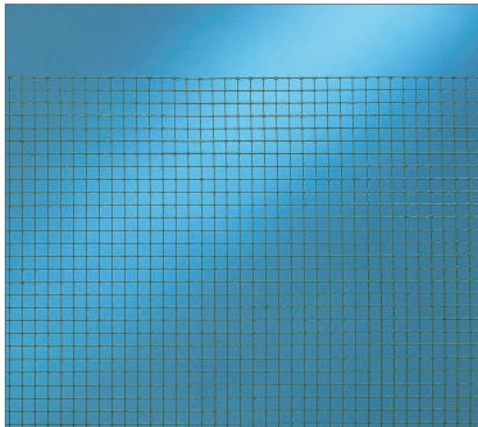

Galvanised (250 gr/m²) or galvanised and plastic coated PVC green BF 6073.

ASSORTMENT CASANET					
Mesh size mm	Wire diameter mm	Rolls lenght 5 Meters	Rolls lenght 10 Meters	Rolls lenght 25 Meters	Rolls height in Meter
Casamet Galva					
6.3 x 6.3	0.73			•	0.50
6.3 x 6.3	0.73			•	1.00
12.7 x 12.7	0.73	•	•	•	0.50
12.7 x 12.7	0.73	•	•	•	1.00
12.7 x 12.7	0.73			•	2.00
12.7 x 12.7	1.00	•		•	0.51
12.7 x 12.7	1.00			•	0.61
12.7 x 12.7	1.00			•	0.81
12.7 x 12.7	1.00	•		•	1.02
12.7 x 12.7	1.00			•	1.50
12.7 x 12.7	1.40			•	1.02
12.7 x 25.4	1.40			•	1.02
19.0 x 19.0	1.00	•			0.50
19.0 x 19.0	1.00			•	1.01
19.0 x 19.0	1.00			•	1.50
19.0 x 19.0	1.40		•	•	0.61
19.0 x 19.0	1.40	•		•	1.01
19.0 x 19.0	1.40			•	1.22
19.0 x 19.0	1.40			•	2.00
19.0 x 19.0	2.00			•	1.01
25.4 x 12.7	1.60			•	1.02
25.4 x 25.4	1.60			•	1.02
25.4 x 25.4	2.00			•	1.02
25.4 x 50.8	2.00			•	1.02
25.4 x 50.8	2.00			•	1.50
50.8 x 50.8	2.00			•	1.02
Casamet Plastic BF 6073					
12.7 x 12.7	0.90	•	•	•	0.50
12.7 x 12.7	0.90	•	•	•	1.00
12.7 x 12.7	0.90			•	1.50
12.7 x 12.7	0.90			•	2.00
19.0 x 19.0	0.90	•			0.50
19.0 x 19.0	0.9	•			1.01

Applications



Functionalities

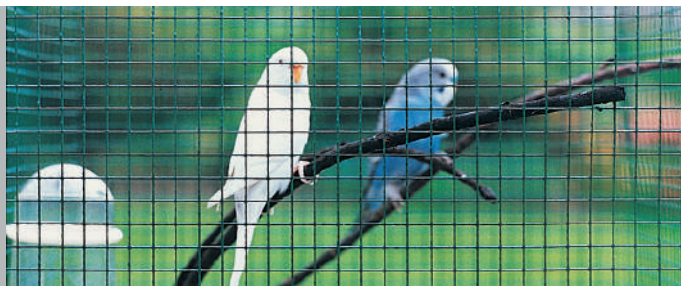

Hexanet®

Specials

Flexible in use, nevertheless rigid metric six twisted wire netting. Only available in galvanized coating. Can be used for (semi-) professional applications.

Product detail

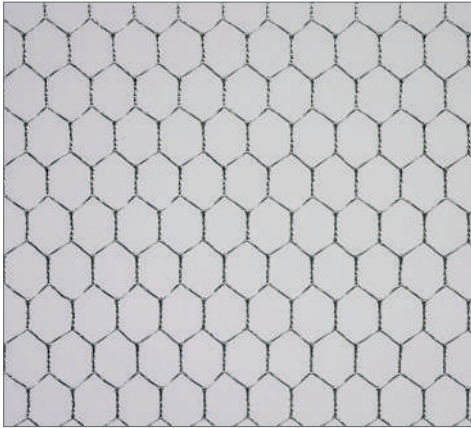

Trigalv® coating (250-275 g/m²).

ASSORTMENT HEXANET			
Length roll	Mesh size mm	Diameter wire mm	Roll height cm
Hexanet Galva			
50 m	13	0,7	100
50 m	16	0,7	50-100
50 m	25	0,8	50-75-100-120-150-200
50 m	50	1	50-100-150-200
25 m	13	0,7	50-100
25 m	20	0,7	50-100-150
25 m	25	0,8	50-100
10 m	13	0,7	50-100
10 m	25	0,8	50-100
5 m	25	0,8	50

Applications



Functionalities





B **BETAFENCE** **Guardiar** **HESCO**

Proud to be a PRÆSIDIAD brand, Betafence is part of a global network, working alongside Guardiar and Hesco as a leader in perimeter security systems and solutions. For more information please visit [praesidiad.com](https://www.praesidiad.com).

Securing What Matters



